



Simple, Rugged Safety Light Screen with Enhanced Features

Superior Performance: Intuitive, easy-to-use safety light screens for machine safeguarding, built to withstand challenging environments common to both manufacturing and packaging.

Easy-to-Use

- **Alignment indicators** are highly visible and intuitive diagnostics simplify setup, facilitate troubleshooting and streamline installation
- **No blind zone** design provides end-to-end sensing to eliminate gaps in detection

Heavy Duty

- **Metal end caps, thick aluminum housing and a recessed window** to avoid damage from impact

Configurations

- **Standard pairs, cascade systems** and extensive accessories to suit a wide variety of safeguarding configurations



Phone: 800.894.0412 - Fax: 888.723.4773 - Web: www.clwtr.com - Email: info@clwtr.com

EZ-SCREEN® LS





EZ-SCREEN® LS
Safety Light Screen

Introducing the EZ-SCREEN® LS

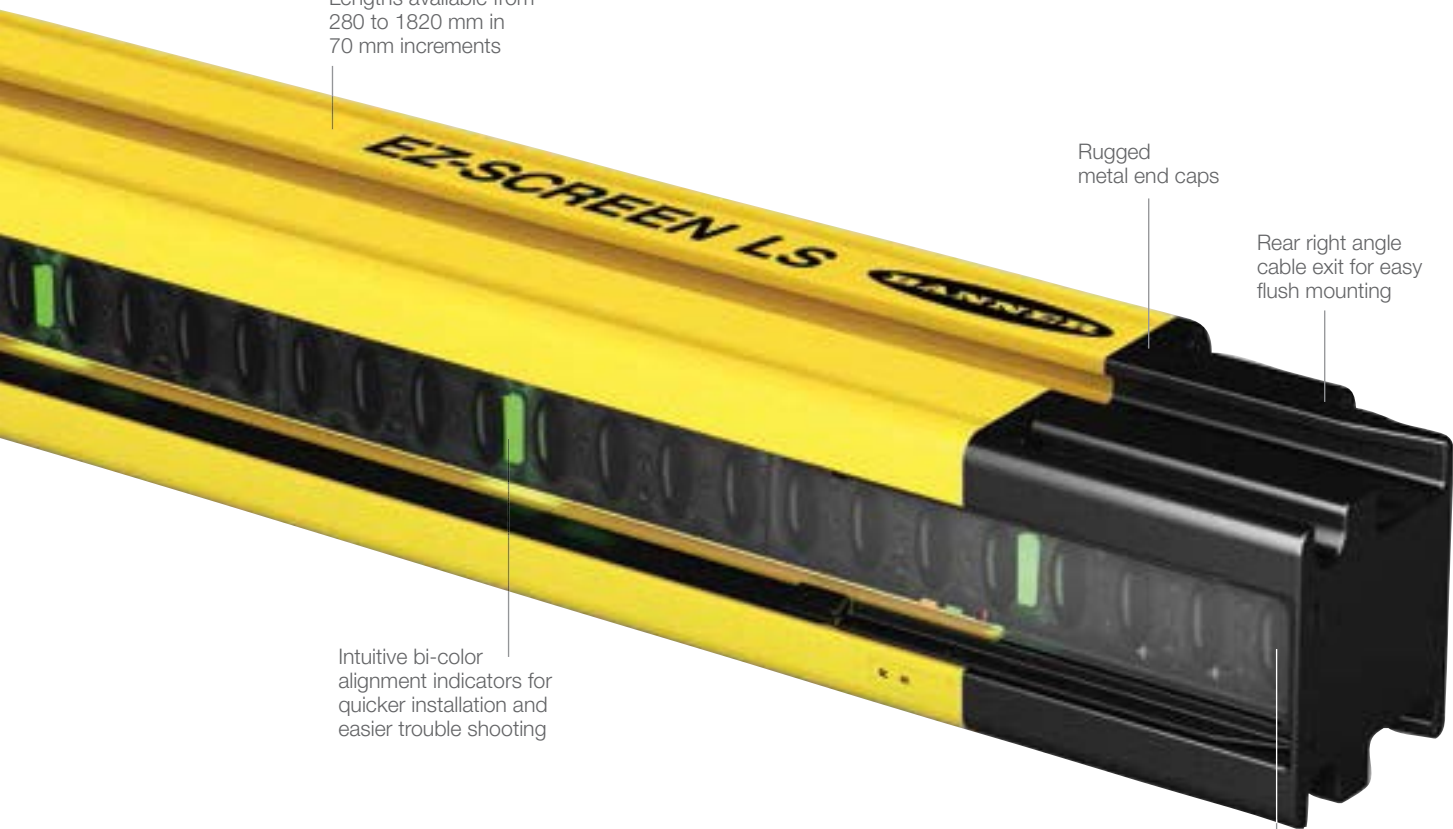

Lengths available from
280 to 1820 mm in
70 mm increments

Intuitive bi-color
alignment indicators for
quicker installation and
easier trouble shooting

Rugged
metal end caps

Rear right angle
cable exit for easy
flush mounting

End-to-end sensing
design (no blind zone)

Available in Three
Resolutions

14 mm

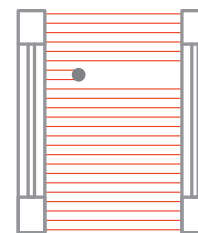

Finger detection

23 mm

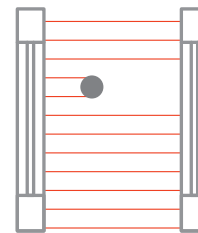

Hand detection

40 mm

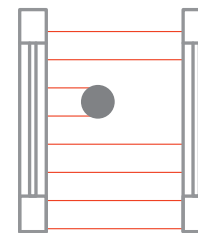

Hand/Arm/Ankle
detection



12 m range

Save Time on Installation

Alignment Indicators

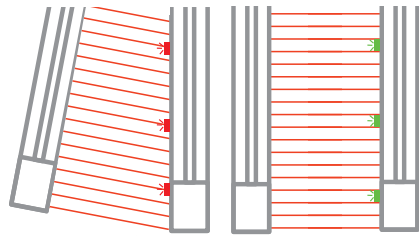

Misaligned

Aligned

Bi-color indicators along the length of the receiver simplify alignment and shorten system setup time

Simplified Wiring

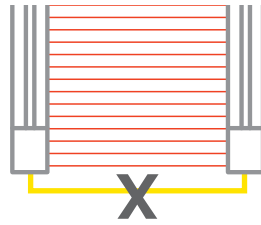

Optical synchronization eliminates the need for wired connection between emitter and receiver

Automatic Cascade Configuration

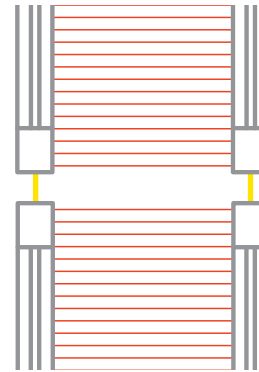

System requires no PC software, DIP switches or additional devices for quick, easy setup

Angled safeguarding of a power press

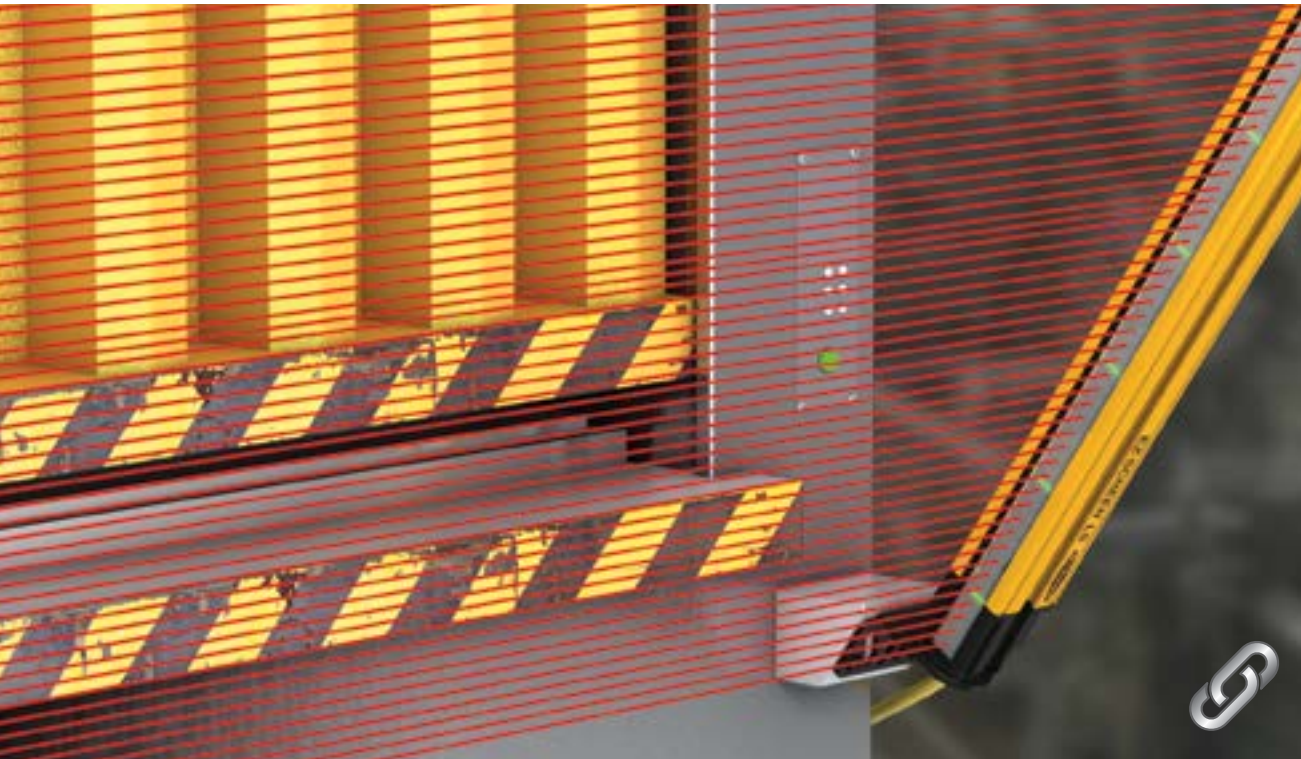

Bi-color red/green status indicator shows if power is applied, and if the safety outputs are ON or OFF

Diagnostic display indicates the total number of blocked beams or specific error conditions





Product Highlights

Intuitive, easy-to-use safety light screen (light curtain) for safeguarding machines and automated equipment in challenging environments.

- Trip output (automatic reset) allows easy interfacing to safety modules, safety controllers, and safety PES/PLCs
- External Device Monitoring (EDM), fault output, and scan code select available on some models
- Dual scan technology makes the sensor highly immune to EMI, RFI, ambient light, weld flash, and strobe light
- Remote fixed blanking available on cascade models allows for greater flexibility in dynamic applications
- Addition of remote or integrated indication lights on cascade models provides clear communication of system status
- Interconnection of E-Stop or Guard Interlocking Switches available on cascadable models

Flexible Installation

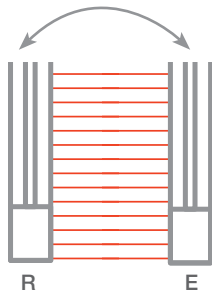

Flexible wiring scheme allows emitter and receiver position to be interchanged without rewiring either unit

Alignment Indicators

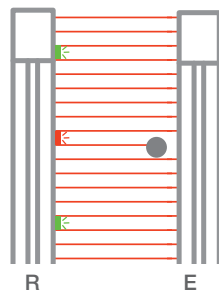

Alignment indicators give clear feedback of which beam is blocked to simplify system installation and minimize downtime

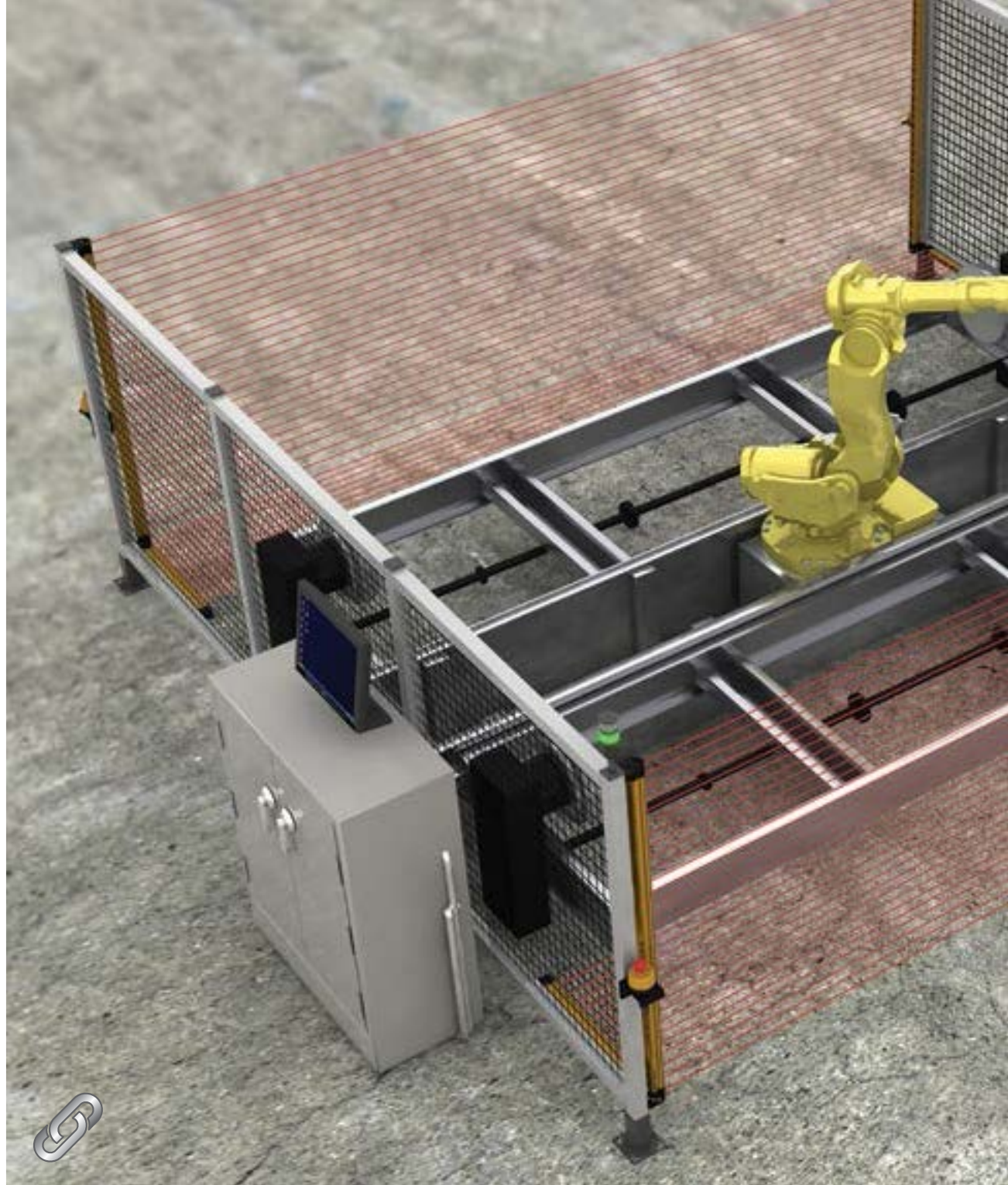

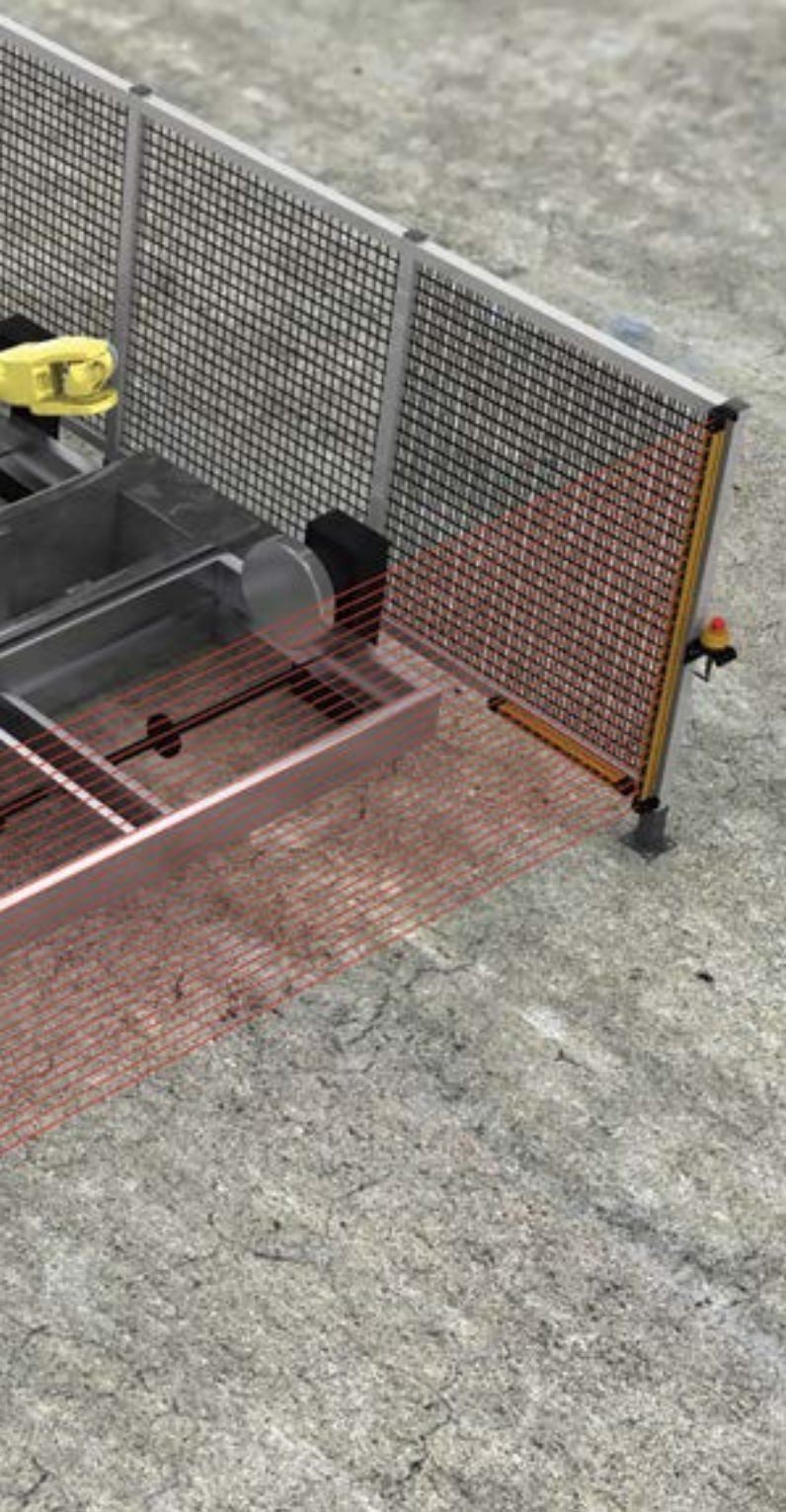

Heavy Duty

Durable design and construction minimizes damage from drops or accidental impact that would require a replacement light screen.

Metal End Cap

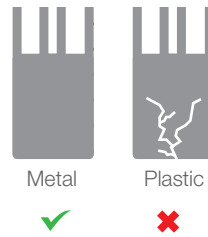

No Connector to Break Off

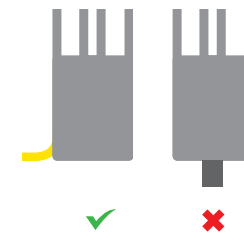

Optional Indicator

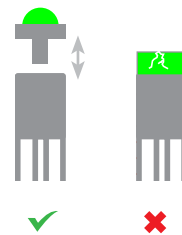

Recessed Window

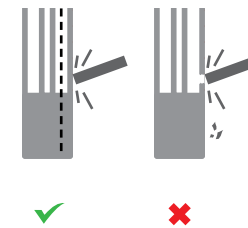

No Dip Switches

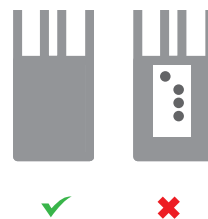

Environmental Rating

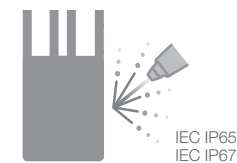

Dual-operator station robotic work cell using four pairs of cascade EZ-SCREEN® LS.



EZ-SCREEN® LS
Safety Light Screen

Optional EZLSA-K30LGR
status indicator available for
use with cascade receivers

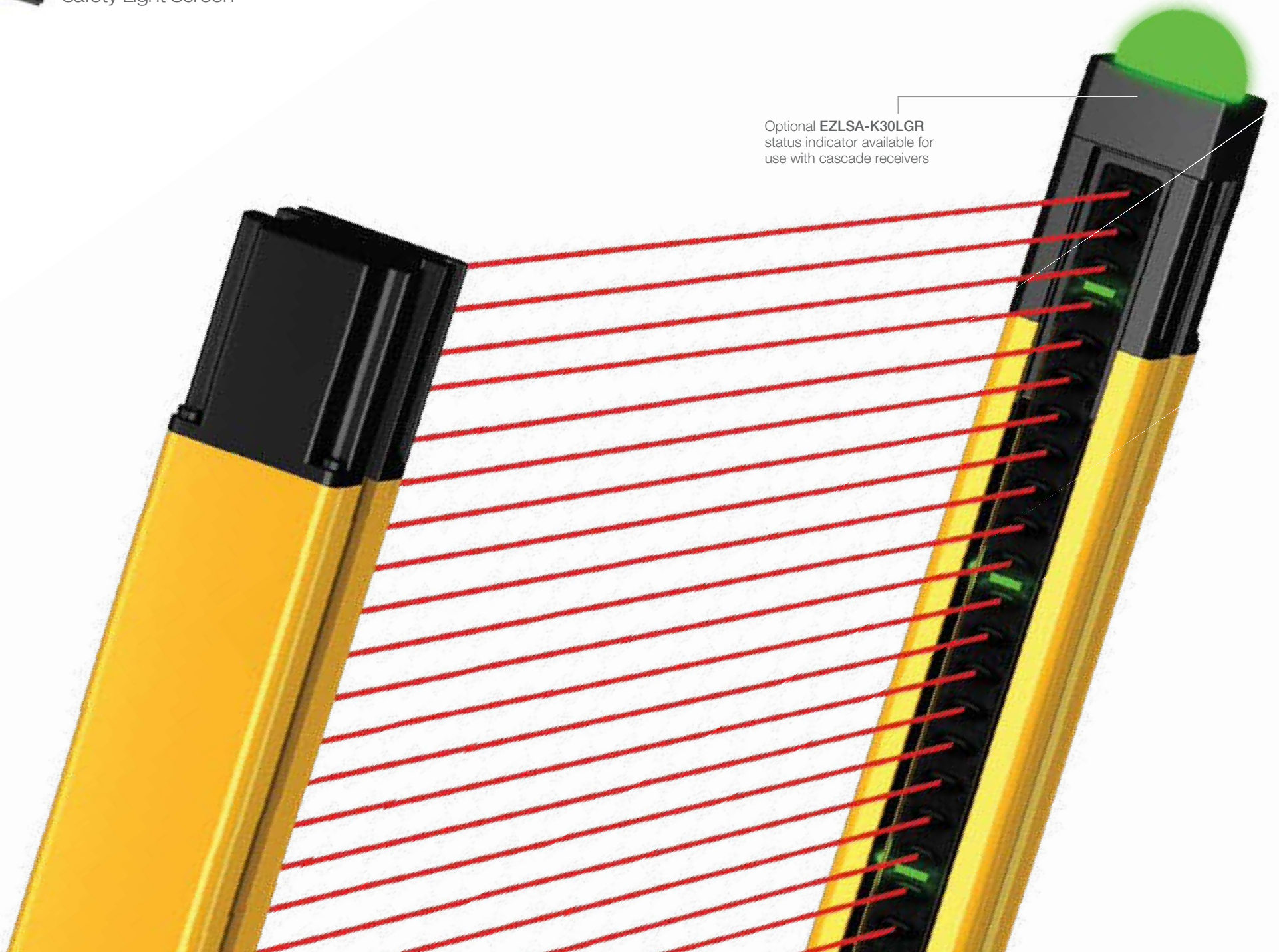

Build a Standard (Non-Cascade) Pair

- Use standard models for a lower cost safety solution
- Cascade models allow for future flexibility and use of optional indicators (see "Build a Cascade System")

1. Choose one

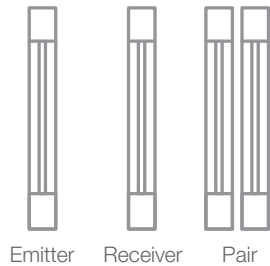

2. Choose your resolution

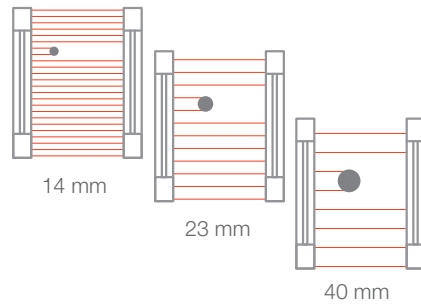

3. Choose your defined area

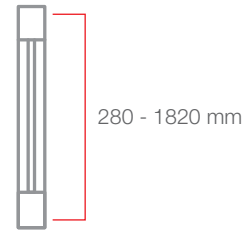

4. Choose your machine interface connection

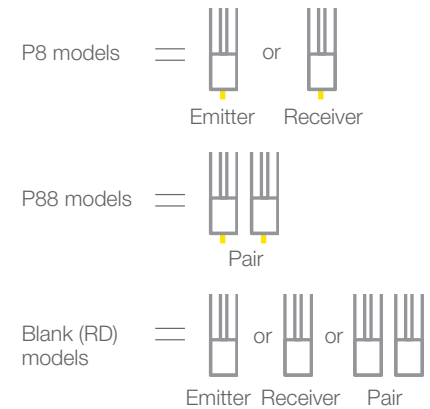

Family	System Type	Resolution	Defined Area		Connection*
SLL	P	14	770		P88
	E = Emitter only	14 = 14 mm	280 = 280 mm	1120 = 1120 mm	P8 = 300 mm pigtail, 8-Pin M12 QD (individual Emitter or Receiver models)
	R = Receiver only	23 = 23 mm	350 = 350 mm	1190 = 1190 mm	P88 = 300 mm pigtail, 8-Pin M12 QD (on BOTH Emitter and Receiver models)
	P = Pair (Emitter and Receiver)	40 = 40 mm	420 = 420 mm	1260 = 1260 mm	Blank = no pigtail, RD connection (for RDLS-8..D cordset)
			490 = 490 mm	1330 = 1330 mm	
			560 = 560 mm	1400 = 1400 mm	
			630 = 630 mm	1470 = 1470 mm	
			700 = 700 mm	1540 = 1540 mm	
			770 = 770 mm	1610 = 1610 mm	
			840 = 840 mm	1680 = 1680 mm	
			910 = 910 mm	1750 = 1750 mm	
			980 = 980 mm	1820 = 1820 mm	
			1050 = 1050 mm		

Example Model Numbers



* 5-pin M12 QD options available (P5 or P55)



EZ-SCREEN® LS
Safety Light Screen

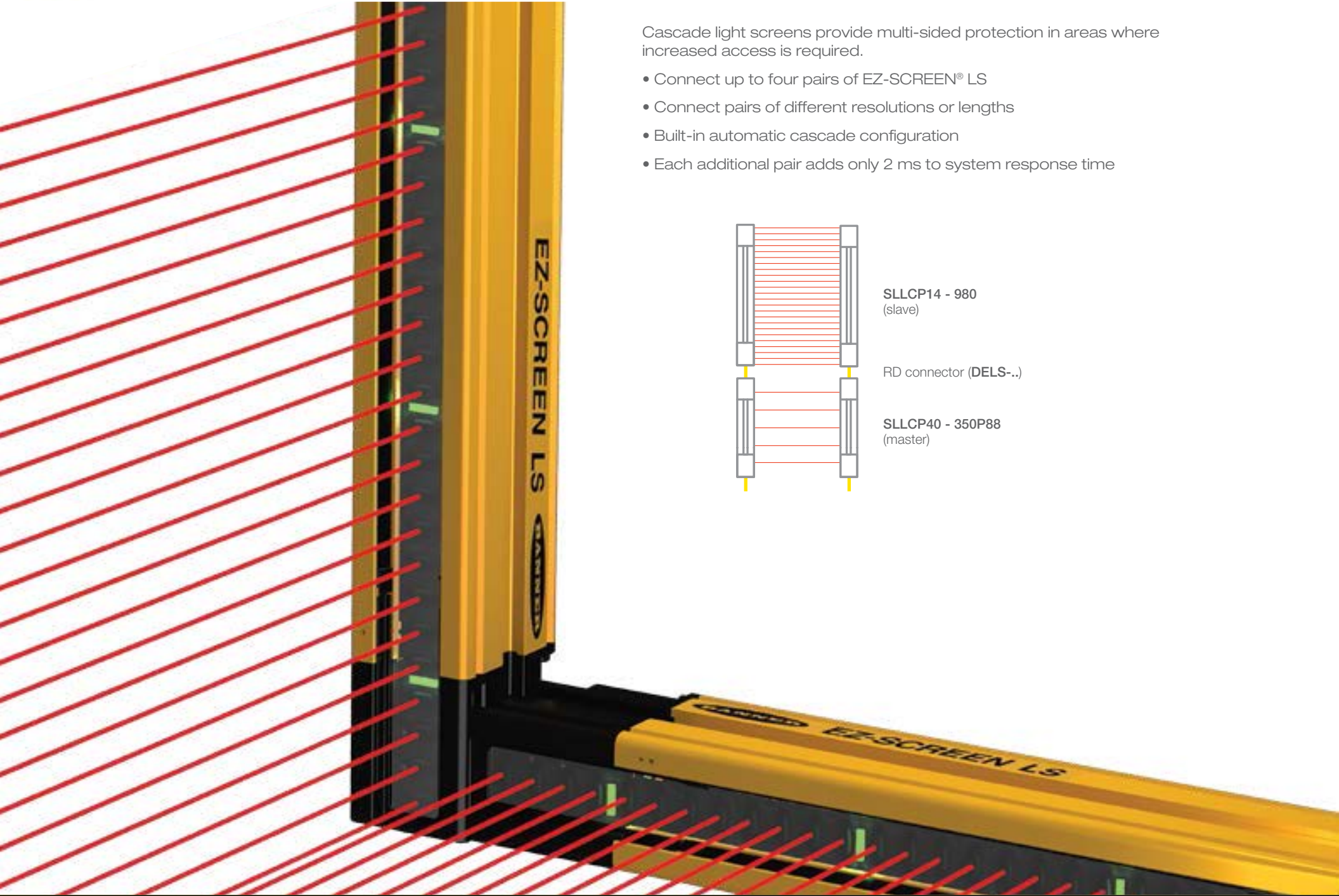

Cascade light screens provide multi-sided protection in areas where increased access is required.

- Connect up to four pairs of EZ-SCREEN® LS
- Connect pairs of different resolutions or lengths
- Built-in automatic cascade configuration
- Each additional pair adds only 2 ms to system response time

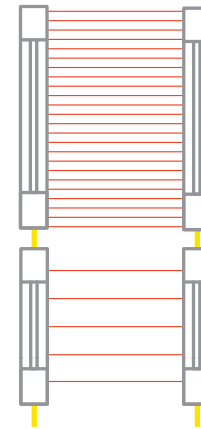

SLLCP14 - 980
(slave)

RD connector (DELS-.)

SLLCP40 - 350P88
(master)

Build a Cascade System

- Determine the configuration of the first EZ-SCREEN® LS pair ("master" connected to the machine control)
- Determine the remaining (second, third or fourth) pairs ("slaves" connected to the master using a DELS-.. cordset)

1. Choose one

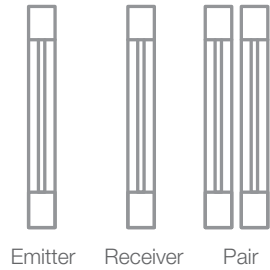

2. Choose your resolution

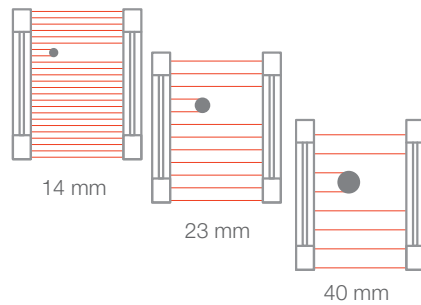

3. Choose your defined area

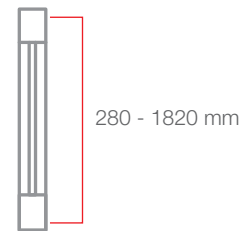

4. Choose your machine interface connection

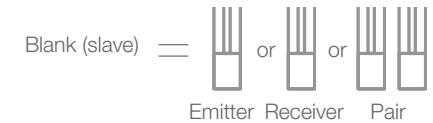
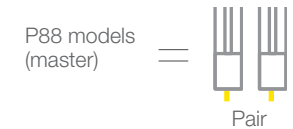
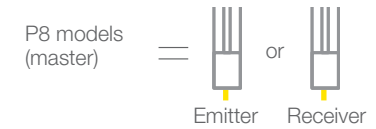

Use DELS-.. cordset for connection between cascade pairs

Family	Cascade	System Type	Resolution	Defined Area	Connection	
SLL	C	P	14	770	P88	
	C = Cascade	E = Emitter only R = Receiver only P = Pair (Emitter and Receiver)	14 = 14 mm 23 = 23 mm 40 = 40 mm	350 = 350 mm 420 = 420 mm 490 = 490 mm 560 = 560 mm 630 = 630 mm 700 = 700 mm 770 = 770 mm 840 = 840 mm 910 = 910 mm 980 = 980 mm 1050 = 1050 mm	1120 = 1120 mm 1190 = 1190 mm 1260 = 1260 mm 1330 = 1330 mm 1400 = 1400 mm 1470 = 1470 mm 1540 = 1540 mm 1610 = 1610 mm 1680 = 1680 mm 1750 = 1750 mm 1820 = 1820 mm	P8 = 300 mm pigtail, 8-Pin M12 QD (first individual Emitter or Receiver models) P88 = 300 mm pigtail, 8-Pin M12 QD (first paired models) Blank = no pigtail, RD connection (for middle/end units in cascade)

* 5-pin M12 QD options available (P5 or P55)

Example Model Numbers



SLLCP14 - 350
Slave

SLLCP14 - 350P88
Master



Machine Interface Connections (Stand-Alone and Master Examples)

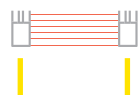

SLLP. - ...
with RDLS-8..D

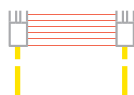

SLLP. - ...P88
with QDE-8..D

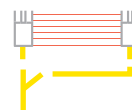

SLLP. - ...P88 with
CSB-M128..M128.. & DEE2R-8..D

RD Cordsets



RDLS-815D 4.6 m (15.1')	RDLS-850D 15.3 m (50.2')
RDLS-825D 8 m (26.2')	

8-Pin M12/ Euro-Style Cordsets



QDE-815D 4.5 m (15')	QDE-850D 15.2 m (50')	QDE-8100D 30.4 m (100')
QDE-825D 7.6 m (25')	QDE-875D 22.8 m (75')	

*5-pin M12 QD options available
(QDE-5..D example QDE-515D)*

8-Pin Male M12 to Dual 8-Pin Female M12 Euro-Style Splitter Cordsets

CSB-M1280M1280 No trunk/ no branches
CSB-M1281M1281 0.3 m (1') trunk/ 2 x 0.3 m (1') branches
CSB-M1288M1281 2.44 m (8') trunk/ 2 x 0.3 m (1') branches
CSB-M12815M1281 4.57 m (15') trunk/ 2 x 0.3 m (1') branches
CSB-M12825M1281 7.62 m (25') trunk/ 2 x 0.3 m (1') branches

Standard cordsets are yellow PVC with black overmold. For black PVC and overmold, add suffix B to the model number (example CSB-M1280M1280B)

8-Pin M12/ Euro-Style Double-Ended Cordsets

DEE2R-81D 0.3 m (1')	DEE2R-825D 7.6 m (25')
DEE2R-83D 0.9 m (3')	DEE2R-830D 9.1 m (30')
DEE2R-88D 2.5 m (8')	DEE2R-850D 15.2 m (50')
DEE2R-812D 3.6 m (12')	DEE2R-875D 22.9 m (75')
DEE2R-815D 4.6 m (15')	DEE2R-8100D 30.5 m (100')

*RD 5-pin options available
(DEE2R-5..D example: DEE2R-51D)*

Cascade System Connections (Master and Slave Examples)

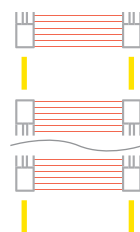

SLLCP. -
with DELS-....E
plus
SLLCP. - ...
with RDLS-8..D

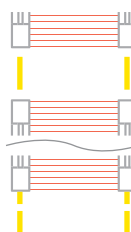

SLLCP. -
with DELS-....E
plus
SLLCP. - ...P88
with QDE-8..D

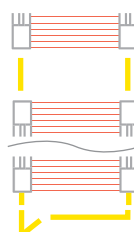

SLLCP. -
with DELS-....E
plus
SLLCP. - ...P88 with
CSB-M128..M128.. & DEE2R-8..D

Double-Ended RD to RD Cordsets

DELS-110E 0.05 m (0.2')	DELS-118E 2.5 m (8.2')	DELS-1125E 8 m (26.2')
DELS-111E 0.3 m (1')	DELS-1115E 4.6 m (15.1')	DELS-1150E 15.3 m (50.2')
DELS-113E 1 m (3.3')		

RD to 8-Pin M12 Euro-Style Cordsets for Remote Fixed Blanking







DELSEF-81D 0.3 m (1')

8-Pin M12 Euro-Style for Panel Connection

PMEF-810D 3 m (10')

(Euro-style connector to 3 m wires, cut to length)



Interfacing Options

		Model	Features	Outputs	EZ-SCREEN® LS Connection	Inputs	Power Supply
Safety Controllers	 <p>Expandable safety controller supports up to eight I/O modules and programs easily using icon-based software</p>	XS26-2	—				
		XS26-2d	display	depends on modules used	RD, P8 (P88), or P5 (P55)	depends on modules used	24 V dc
		XS26-2e	ethernet				
		XS26-2de	display, ethernet				
	 <p>Flexible, efficient safety controller has small footprint and features intuitive, icon-based programming environment</p>	SC26-2	—				
		SC26-2d	display	2 pair (4 PNP)	RD, P8 (P88), or P5 (P55)	26 terminals	24 V dc
		SC26-2e	ethernet				
		SC26-2de	display, ethernet				
	 <p>Completely configurable and flexible safety controller that can easily replace multiple dedicated safety modules</p>	SC22-3-S	display				
SC22-3-SU1		display (programming tool, USB cable)	3 pair (6 PNP)	RD, P8 (P88), or P5 (P55)	22 terminals	24 V dc	
SC22-3E-S		display, ethernet					
SC22-3E-SU1		display, ethernet (programming tool, USB cable)					
Safety Modules	 <p>Monitors solid-state PNP OSSD safety outputs and provides latching (manual reset) function for applications requiring a reset</p>	UM-FA-9A					6 amp redundant contacts
		UM-FA-11A	6 amp redundant contacts	2 NO, 1 NC			
	 <p>Muting modules suspend safeguarding during non-hazardous portion of the machine cycle</p>	MMD-TA-11B	terminal connections	2 NO	RD, P8 (P88), or P5 (P55)	2 redundant	24 V dc
		MMD-TA-12B	terminal connections	2 OSSD			
	 <p>Interface module monitors solid-state PNP OSSD safety outputs and requires monitoring by External Device Monitoring (EDM)</p>	IM-T-9A	6 amp redundant contacts	3 NO	RD or P8 (P88)	1 redundant	24 V dc
		IM-T-11A	6 amp redundant contacts	2 NO, 1 NC			
Contactors	 <p>Two contactors are required for higher levels of safety performance and requires monitoring by External Device Monitoring (EDM).</p>	11-BG00-31-D-024	10 amp positive-guided contactor	3 NO, 1 NC	RD or P8 (P88)	1 per contactor	24 V dc
		BF1801L024	18 amp positive-guided contactor (NC contact rated at 10 amps)	3 NO, 1 NC			



EZ-SCREEN® LS Safety Light Screen

Operating Conditions	-20 °C to +55 °C (-4 °F to +131 °F) 95% maximum relative humidity (non-condensing)
Environmental Rating	IEC IP65/IEC IP67
Supply Voltage at the Device	24 V dc ±15% (use a SELV-rated power supply according to EN IEC 60950). The external voltage supply must be capable of buffering brief mains interruptions of 20 ms, as specified in IEC/EN 60204-1.
Residual Ripple	±10% maximum
Short Circuit Protection	All inputs and outputs are protected from short circuits to +24 V dc or dc common
Electrical Safety Class	III (per IEC 61140: 1997)
Operating Range	0.1 m to 12 m (4 in to 39 ft) — Range decreases with use of mirrors and/or lens shields: <ul style="list-style-type: none"> • Lens shields — approx 10% less range per shield • Glass-surface mirrors — approx 8% less range per mirror See the specific mirror datasheet for more information
Resolution	14 mm, 23 mm, or 40 mm, depending on model

Effective Aperture Angle (EAA)	Meets Type 4 requirements per IEC 61496-2
Enclosure	Extruded aluminum housing with yellow polyester powder finish standard and well-sealed, rugged die-cast zinc end caps, acrylic lens cover
Mounting Hardware	Emitter and receiver each are supplied with a pair of swivel end-mounting brackets (EZLSA-MBK-11). Models 980 mm and longer are supplied with an additional center-mount bracket (EZLSA-MBK-12) for center support in applications with significant vibration. Mounting brackets are 8-gauge cold-rolled steel, black zinc finish.
Safety Rating	Type 4 per IEC 61496-1, -2 Category 4 PL e per EN ISO13849-1 SIL3 per IEC 61508; SIL CL3 per IEC 62061
Shock and Vibration	Components have passed vibration and shock tests according to IEC 61496-1. This includes vibration (10 cycles) of 10-55 Hz at 0.35 mm (0.014 in) single amplitude (0.70 mm peak-to-peak) and shock of 10 g for 16 milliseconds (6,000 cycles).
Certifications	 



Accessories



K30LGRXPQ
requires 4-pin QD



K50LGRXPQ
requires 4-pin QD



TL50GRQ
requires 4-pin QD



**RD to 4-Pin M12/
Euro-Style Cordsets**
Connects indicators to a cascade receiver

- DELSEF-40D**
0.5 m (0.02')
- DELSEF-41D**
0.3 m (1')
- DELSEF-43D**
1 m (3.3')
- DELSEF-48D**
2.5 m (8.2')
- DELSEF-415D**
4.6 m (15.1')



EZLSA-K30LGR
Connects directly to SLLCR... cascade receiver



EZLSA-MBK-11
8-ga. black cold-rolled steel (end-mount bracket—two supplied with each sensor)



EZLSA-MBK-16
8-ga. black cold-rolled steel (optional side mount bracket)



EZLSA-MBK-12
8-ga. black cold-rolled steel (center-mount bracket—one supplied with each sensor ≥ 980 mm)



EZLSA-MBK-20
8-ga. black cold-rolled steel (optional end-mount bracket for slotted aluminum framing)



Link to data sheets

SSA-EB Series Lighted Emergency Stop Push Buttons
Illuminated 30mm Mount Electro-Mechanical Push Buttons

Features

- Rugged design, easy installation with no assembly or industrial wiring required
- Push-to-stop, hold-to-release, or pull-to-release operation per EC60947-5-5
- Locking release complies with ISO 13801, direct (push-in), opening operation per IEC 60947-5-5
- Compliant with ANSI B11.19, ANSI NIPPA70, and IECEN 60204-1 Emergency Stop requirements
- Lock-release indicator, normally N.C. contacts will open if the contact block is separated from the actuator
- Spill RESISTANT-IP65 (Dishwasher)
- Models with YELLOW and RED indication of activation (armed or depressed) without button
- "Emergency Stop" legend included

Models SSA-EB... series are "lock-on/hold" electro-mechanical emergency stop push buttons. When the button is armed, the switch's safety contacts (N.C.) are closed and its monitoring contacts (N.O.) are open. When the button is pushed, the switch's safety contacts open and the monitoring contacts close. The contacts remain in this condition until the push button is manually returned by pulling or twisting (pressure on the light push button actuator).

The SSA-EB...-ECC... series have a 30 mm mounting base similar to Banner's QTS, VTS, and STB Opti-Touch™ mounting without requiring an additional enclosure. The EZ-COSET™ Illumination top allows for easy identification of button. An armed button is either a steady yellow illumination or OFF; a pushactuated button is indicated by a red optical panel above an armed button to facilitate a steady red to indicate a machine stop or emergency stop.

Model	Stop Contacts	Indicators
SSA-EB-PL-YR-30ECC04	2 N.C./1 N.O. E-Stop contacts	YELLOW & RED (PL)
SSA-EB-PL-YR-30ECC04	2 N.C./1 N.O. E-Stop contacts	RED (Flashing/Still)

Read this before proceeding!
Following all local, state, and national laws, rules, codes, and regulations relating to Banner Engineering Corp. has made every effort to provide complete application, installation, and operation instructions for the use or installation of this product to the best of our ability. Banner Engineering Corp. has made every effort to provide complete application, installation, and operation instructions for the use or installation of this product to the best of our ability. Banner Engineering Corp. has made every effort to provide complete application, installation, and operation instructions for the use or installation of this product to the best of our ability. Banner Engineering Corp. has made every effort to provide complete application, installation, and operation instructions for the use or installation of this product to the best of our ability.



Link to catalog

Link to the Banner website

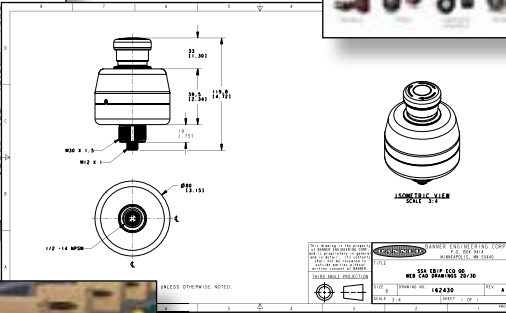

Link to CAD files



Link to videos

