



# Signal Tower Lights

Multi-segment LED tower lights give machines a voice, conveying critical information in a clear, visual manner. AC and DC voltage, fourteen color options, six audible alarm styles, multiple intensity levels, three connection types and optional wireless or IO-Link communication give almost limitless possibilities in both preassembled and field configured units.

# Selection Guide



Tower Lights

|                                   |          |          |          |          |          |
|-----------------------------------|----------|----------|----------|----------|----------|
| Page                              | 48       | 52       | 54       | 56       | 58       |
| Family Name                       | TL70     | TL50     | TL50C    | TL50BL   | CL50     |
| DC or AC Power                    | AC or DC | AC or DC | AC or DC | AC or DC | AC or DC |
| Audible Options                   |          |          |          |          |          |
| Daylight Visible                  |          |          |          |          |          |
| Segment Diameter (mm)             | 70       | 50       | 50       | 50       | 50       |
| Mounting Hole Diameter (mm)       | 30       | 30       | 30       | 30       | 30       |
| Multiple Colors per Light Segment |          |          |          |          |          |
| IP Rating                         | IP65     | IP67     | IP67     | IP67     | IP67     |
| IO-Link                           |          |          |          |          |          |
| Wireless                          |          |          |          |          |          |
| Modular Construction              |          |          |          |          |          |

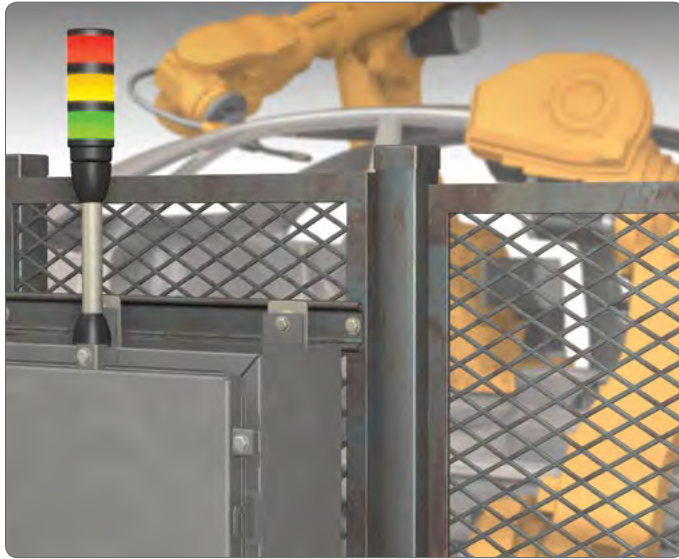

TL50

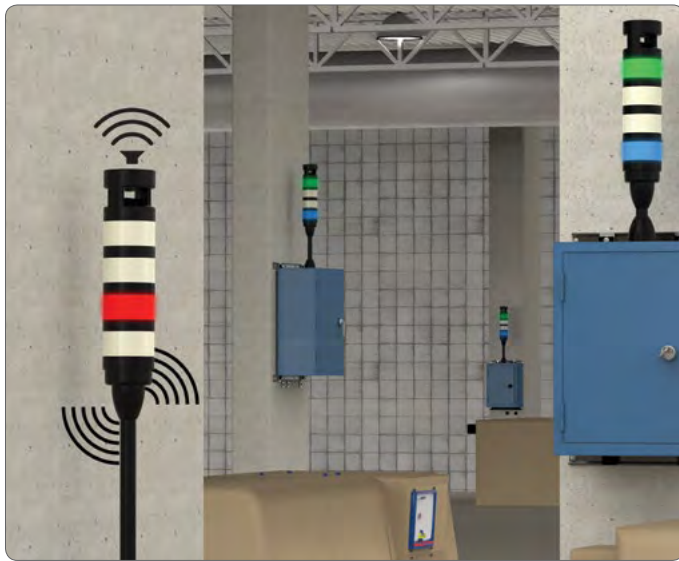

TL70 Wireless



CL50



## TL70 Tower Lights

---

- 70 mm diameter with bright, colored LEDs for long range visibility
- Light segments appear gray when off to eliminate false indication from ambient light
- Modular design and simple wiring for fast field configuration; preassembled models also available
- Rugged, water-resistant IP65 housing with UV stabilized material
- Top-mounted audible modules from 75 to 101 dB, including multi-tone and programmable audible models allow for custom alerts or announcements; all work with the same standard bases
- Wireless base and segment models quickly enable remote monitoring and control of status lights; unleash IIOT capability
- Match your machine with a choice of black or gray housing

# Build Your Own Tower Light

## Standard Base

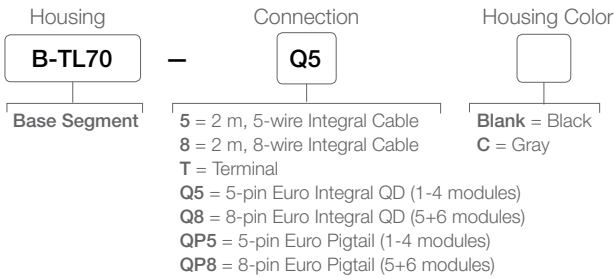

## AC Base

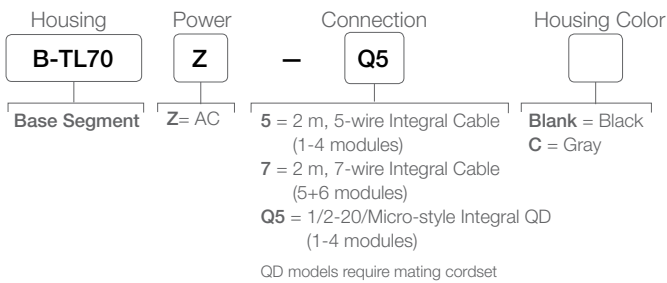

## Wireless Base

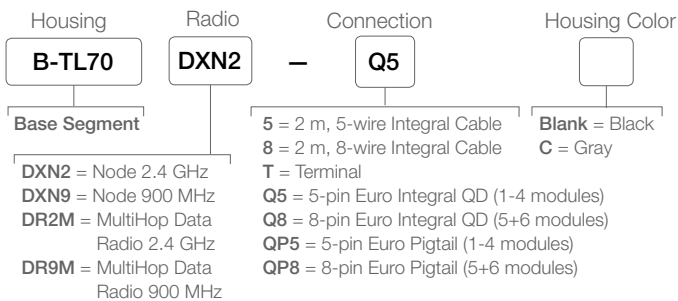

\* To have color name etched on a segment, add -L to the end of the model number

## Single-Color Light Segments

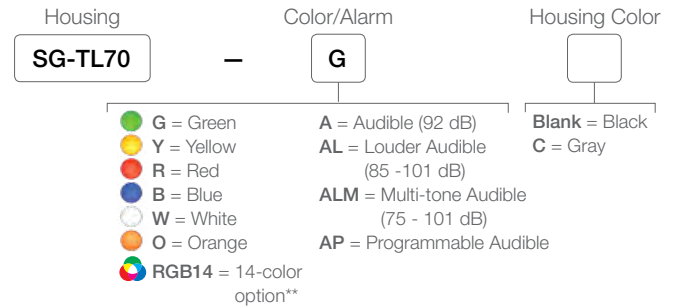

## Multicolor Light Segments

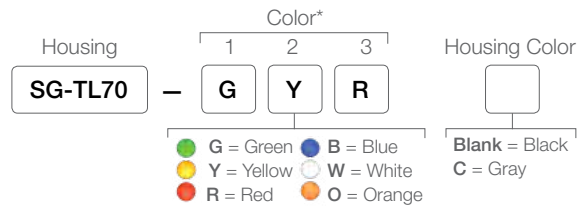

## Wireless Communication Segment

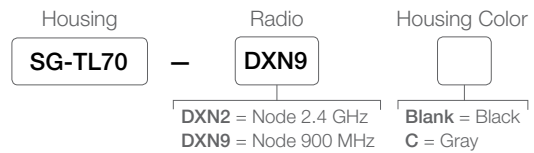

\*\* Green, Yellow, Red, Blue, White, Cyan, Magenta, Orange, Amber, Lime Green, Spring Green, Sky Blue, Violet and Rose



The wireless communication segment quickly twists onto any TL70 base, enabling remote monitoring and control without requiring constant power or expensive wiring.

# Order a Preassemble Tower Light

## Preassembled TL70

Color\*\*/Position

Housing: **TL70**

1: **G** 2: **Y** 3: **R** 4: **B** 5: **W** 6: **O**

Audible\* 

Housing Color 

Connection: **Q**

**G** = Green    **B** = Blue  
**Y** = Yellow   **W** = White  
**R** = Red      **O** = Orange

**Blank** = None  
**A** = Audible (92 dB)  
**AL** = Louder Audible (85 - 101 dB)  
**ALM** = Multi-tone Audible\*\* (75 - 101 dB)  
**AP** = Programmable Audible

**Blank** = Black  
**C** = Gray

**Blank** = 2 m Integral Cable  
**T** = Terminal Wired  
**Q** = Euro Integral QD  
**QP** = Euro Pigtail QD  
 QD models require mating cordset

\* For audible only, leave colors blank  
\*\* Not available with 6 light models

## Preassembled TL70 AC

Color\*\*/Position

Housing: **TL70Z**

1: **G** 2: **Y** 3: **R** 4: **B** 5: **W** 6: **O**

Audible\* 

Housing Color 

Connection: **Q**

**G** = Green    **B** = Blue  
**Y** = Yellow   **W** = White  
**R** = Red      **O** = Orange

**Blank** = None  
**A** = Audible (92 dB)  
**AL** = Louder Audible (85 - 101 dB)  
**ALM** = Multi-tone Audible\*\* (75 - 101 dB)  
**AP** = Programmable Audible

**Blank** = Black  
**C** = Gray

**Blank** = 2 m Integral Cable  
**Q** = 1/2-20/Micro-style Integral QD  
 QD models require mating cordset

\* For audible only, leave colors blank  
\*\* Not available with 6 light models

## Preassembled TL70 Wireless

Color\*\*/Position

Housing: **TL70**

Radio: **DXN2**

1: **G** 2: **Y** 3: **R** 4: **B** 5: **W** 6: **O**

Audible\* 

Housing Color 

Connection: **Q**

**G** = Green    **W** = White  
**Y** = Yellow   **O** = Orange  
**R** = Red      **B** = Blue  
**Blank** = None

**Blank** = None  
**A** = Audible (92 dB)  
**AL** = Louder Audible (85 - 101 dB)  
**ALM** = Multi-tone Audible\*\* (75 - 101 dB)  
**AP** = Programmable Audible

**Blank** = Black  
**C** = Gray

**Blank** = 2 m Integral Cable  
**Q** = Euro Integral QD  
**QP** = Euro Pigtail QD  
 QD models require mating cordset

**DXN2** = Node 2.4 GHz  
**DXN9** = Node 900 MHz  
**DR2M** = MultiHop Data Radio 2.4 GHz  
**DR9M** = MultiHop Data Radio 900 MHz

\* For audible only, leave colors blank  
\*\* Not available with 6 light models



Laser  
Marking  
Available

| Color Count | AC Tower Height (H) | AC Tower Height with Audible (H) | DC Tower Height (H) | DC Tower Height with Audible (H) |
|-------------|---------------------|----------------------------------|---------------------|----------------------------------|
| 1           | 155.6 mm            | 212.3 mm                         | 87.6 mm             | 144.3 mm                         |
| 2           | 205.3 mm            | 262.0 mm                         | 137.3 mm            | 194.0 mm                         |
| 3           | 255.0 mm            | 311.7 mm                         | 187.0 mm            | 243.7 mm                         |
| 4           | 304.7 mm            | 361.4 mm                         | 236.7 mm            | 293.4 mm                         |
| 5           | 354.4 mm            | 411.1 mm                         | 286.4 mm            | 343.1 mm                         |
| 6           | 404.1 mm            | NA                               | 336.1 mm            | NA                               |

**Supply Voltage**

12 to 30 V dc  
100 to 240 V ac

**Construction**

Bases and Covers: Polycarbonate  
Light Segment: Polycarbonate

**Environmental Rating**

IP65

**Operating Temperature**

-40 to +50 °C (-40 to +122 °F)

**Certifications**



Accessories are listed on pages 61



## TL50 Tower Lights

---

- Available in models featuring IO-Link communication for easy integration into most industrial networks and remote control and monitoring of light and audible segments in the fixture
- Built-to-order configure your model today using our online tool
- Installs directly on machine quickly and easily with pre-wired or quick-disconnect options no assembly required
- Features a completely self-contained design no controller needed
- Displays up to 7 colors in a single tower choice of 10 colors in standard brightness and 5 colors in high brightness tower lights
- Allows multiple lights to be on simultaneously
- Eliminates false indication from ambient light; indicators appear gray when off
- Available in Universal AC Voltage models





## Standard and High-Brightness

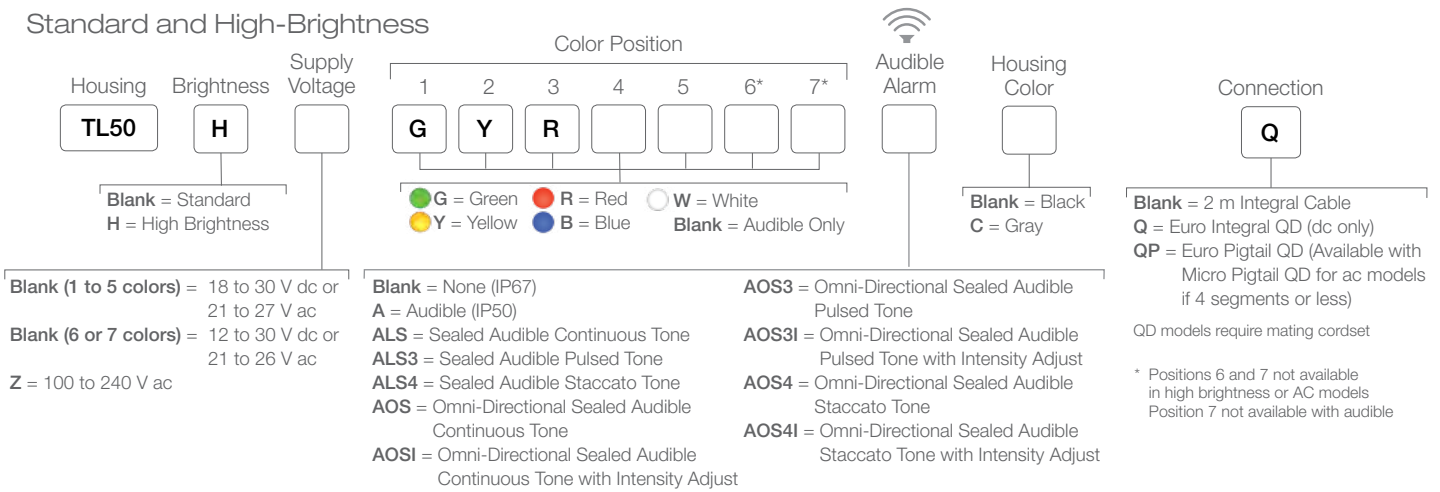

## Standard with IO-Link

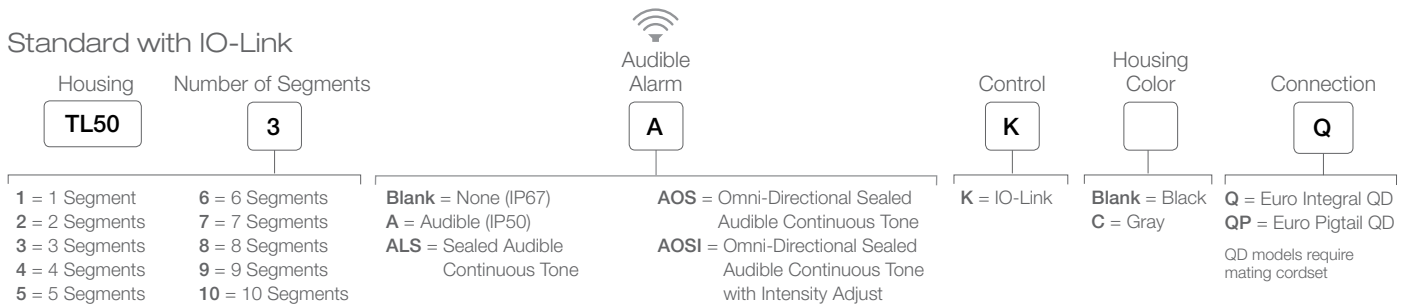

|                              |   |
|------------------------------|---|
| <b>Supply Voltage</b>        | 18 to 30 V dc or 21-27 V ac; 100 to 240 V ac<br>>5 segments: 12-30 V dc or 21-26 V ac                               |
| <b>Construction</b>          | Bases and Covers: ABS<br>Light Segment: Polycarbonate   |
| <b>Environmental Rating</b>  | General-Purpose and Sealed Audible: IEC IP67<br>Standard Audible: IEC IP50  |
| <b>Operating Temperature</b> | General-Purpose:<br>-40 to +50 °C (-40 to +122 °F)<br>Standard and Sealed Audible:<br>-20 to +50 °C (-4 to +122 °F) |
| <b>Certifications</b>        | CE, UL LISTED   |



**Audible**  
max. intensity 92 db @ 1 meter (typical)

**Sealed Audible**  
max. intensity 94 db @ 1 meter (typical)

**Sealed Omni-Directional Audible**  
Standard: max. intensity 99 db @ 1 meter (typical)  
Intensity Adjust: max. intensity 95 db @ 1 meter (typical)

Laser Marking Available

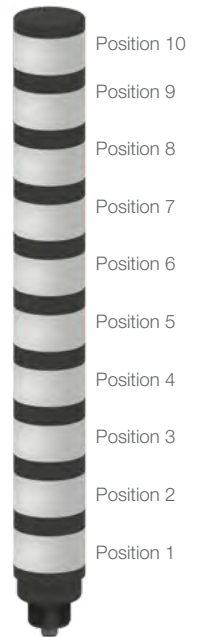

| Tower Height (H) | Tower Height (H)     |              |                     | 100 to 240 V AC |
|------------------|----------------------|--------------|---------------------|-----------------|
|                  | General-Purpose IP67 | Audible IP50 | Sealed Audible IP67 |                 |
| 0                | —                    | 92.0 mm      | 74.4 mm             | 88.4 mm         |
| 1                | 61.2 mm              | 92.0 mm      | 115.1 mm            | 129.1 mm        |
| 2                | 101.9 mm             | 132.7 mm     | 155.8 mm            | 169.8 mm        |
| 3                | 142.6 mm             | 173.4 mm     | 196.5 mm            | 210.5 mm        |
| 4                | 183.3 mm             | 214.1 mm     | 237.2 mm            | 251.2 mm        |
| 5                | 224.0 mm             | 254.8 mm     | 277.9 mm            | 291.1 mm        |
| 6                | 264.7 mm             | 295.5 mm     | 318.6 mm            | 332.6 mm        |
| 7                | 305.4 mm             | 339.2 mm     | 359.3 mm            | 373.3 mm        |
| 8                | 346.1 mm             | 379.9 mm     | 400.0 mm            | 414.0 mm        |
| 9                | 386.8 mm             | 420.6 mm     | 440.7 mm            | 454.7 mm        |
| 10               | 427.5 mm             | 461.3 mm     | 481.4 mm            | 495.4 mm        |

Add 69 mm to any of these heights to get total height

Area in gray are IO-Link models only. Not available in AC.

Accessories are listed on pages 61



## TL50C Compact Tower Lights

---

- Ideal for status indication on small to mid-size pieces of equipment
- Displays up to five stacked colors in one tower with universal ac voltage and up to seven stacked colors in one tower with standard dc voltage
- Half the height of standard TL50 models
- Bright, uniform lighted segments with 10 color choices available
- Available with standard, sealed or Omni-Directional audible
- Compact, sleek, rugged design with IP67 models available
- DC models work down to 12 volts, allowing for use in battery-powered mobile equipment



## Standard Compact

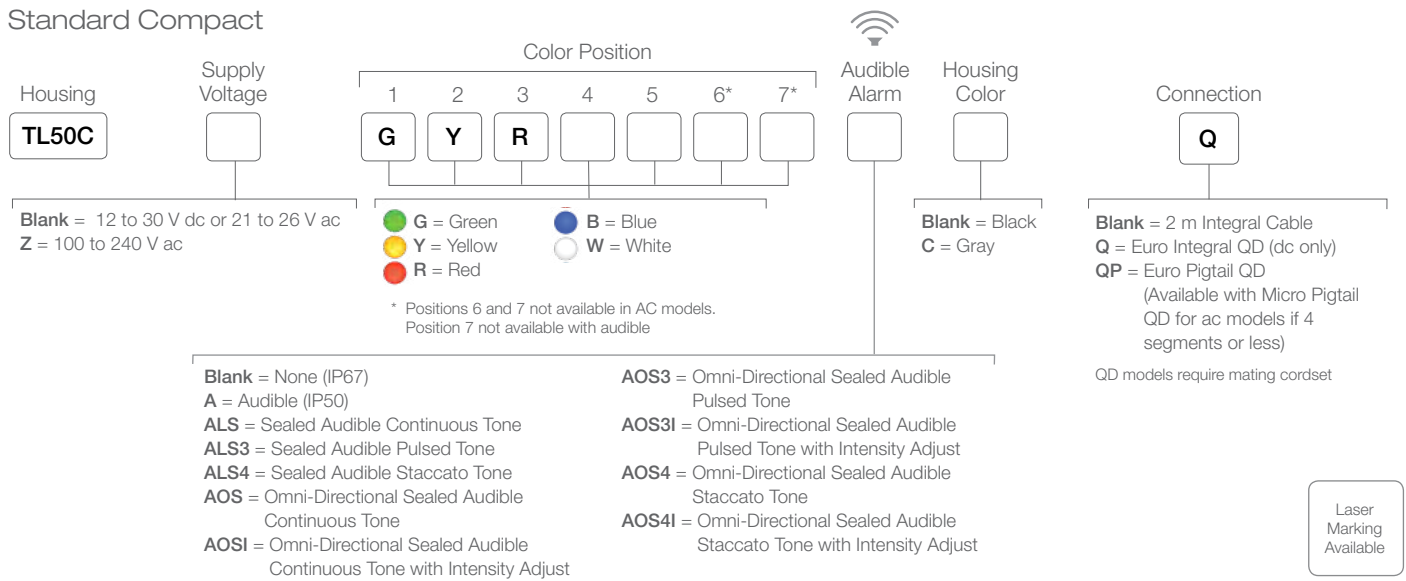

## Compact with IO-Link

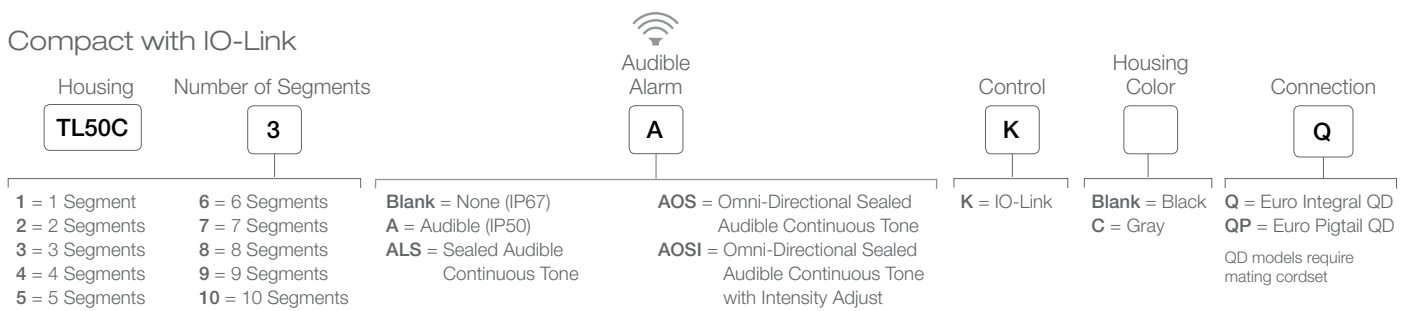

|                              |   |
|------------------------------|---|
| <b>Supply Voltage</b>        | 12 to 30 V dc or 21-27 V ac; 100 to 240 V ac  |
| <b>Construction</b>          | Bases and Covers: ABS<br>Light Segment: Polycarbonate   |
| <b>Environmental Rating</b>  | General-Purpose and Sealed Audible:<br>IEC IP67<br>Standard Audible:<br>IEC IP50                                    |
| <b>Operating Temperature</b> | General-Purpose:<br>-40 to +50 °C (-40 to +122 °F)<br>Standard and Sealed Audible:<br>-20 to +50 °C (-4 to +122 °F) |
| <b>Certifications</b>        | CE, UL LISTED   |



| Tower Height (H) | Tower Height (H)     |              |                     |                         | 100 to 240 V AC  |
|------------------|----------------------|--------------|---------------------|-------------------------|--|
|                  | General-Purpose IP67 | Audible IP50 | Sealed Audible IP67 | Sealed Omni-Directional |  |
| 1                | 46.2 mm              | 77.1 mm      | 100.2 mm            | 114.2 mm                |  |
| 2                | 72.0 mm              | 102.9 mm     | 126.0 mm            | 140.0 mm                |  |
| 3                | 97.8 mm              | 128.7 mm     | 151.8 mm            | 165.8 mm                |  |
| 4                | 123.6 mm             | 154.5 mm     | 177.6 mm            | 191.6 mm                |  |
| 5                | 149.4 mm             | 180.3 mm     | 203.4 mm            | 217.4 mm                |  |
| 6                | 175.2 mm             | 206.1 mm     | 229.2 mm            | 243.4 mm                |  |
| 7                | 201.0 mm             | 231.9 mm     | 255.0 mm            | 269.2 mm                |  |
| 8                | 226.8 mm             | 257.7 mm     | 280.8 mm            | 295.0 mm                | Area in gray are IO-Link models only. Not available in AC. |
| 9                | 252.6 mm             | 283.5 mm     | 306.6 mm            | 320.8 mm                |  |
| 10               | 278.4 mm             | 309.3 mm     | 332.4 mm            | 346.6 mm                |  |

General-Purpose, Audible, Sealed Audible, Sealed Omni-Directional, 100 to 240 V ac

ø 50 mm

Accessories are listed on pages 61



## TL50BL Beacon Tower Lights

---

- Housing is UV stabilized, making it suitable for use in outdoor environments
- Highly visible indication for indoor or outdoor applications
- Compact, stylish design with rotating and flashing options
- Audible alert: continuous, pulsed and staccato models available
- Omni-Directional audible models provide clear annunciation in the noisiest environments
- Models available with rugged, water-resistant IP67 housing



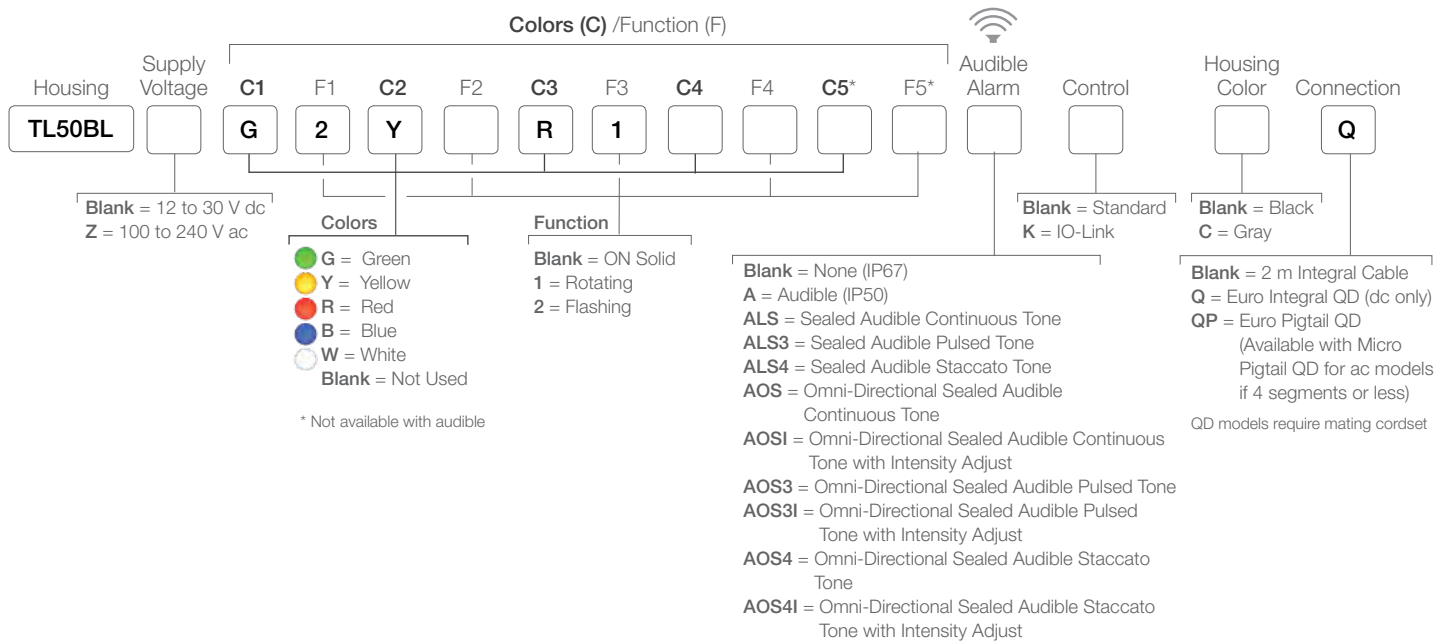

|                              |   |  |  |
|------------------------------|---|--|--|
| <b>Supply Voltage</b>        | 12 to 30 V dc or 21-27 V ac<br>100 to 240 V ac  | <p><b>Audible</b><br/>max. intensity 92 db @ 1 meter (typical)</p> <p><b>Sealed Audible</b><br/>max. intensity 94 db @ 1 meter (typical)</p> <p><b>Sealed Omni-Directional Audible</b><br/>Standard: max. intensity 99 db @ 1 meter (typical)<br/>Intensity Adjust: max. intensity 95 db @ 1 meter (typical)</p> |  |
| <b>Construction</b>          | Bases and Covers: ABS<br>Light Segment: Polycarbonate   |  |  |
| <b>Environmental Rating</b>  | General-Purpose and Sealed Audible: IEC IP67<br>Standard Audible: IEC IP50  |  |  |
| <b>Operating Temperature</b> | General-Purpose:<br>-40° to +50° C (-40° to +122° F)<br>Standard and Sealed Audible:<br>-20° to +50° C (-4° to +122° F) |  |  |
| <b>Certifications</b>        |   |  |  |



| Color Count | Tower Height (H)     |                           |                     |                         | 100 to 240 V AC                                       |
|-------------|----------------------|---------------------------|---------------------|-------------------------|---|
|             | General-Purpose IP67 | Audible <sup>†</sup> IP50 | Sealed Audible IP67 | Sealed Omni-Directional |   |
| 1           | 46.2 mm              | 77.1 mm                   | 100.2 mm            | 114.2 mm                |   |
| 2           | 72.0 mm              | 102.9 mm                  | 126.0 mm            | 140.0 mm                | Add 69 mm to any of these heights to get total height |
| 3           | 97.8 mm              | 128.7 mm                  | 151.8 mm            | 165.8 mm                |   |
| 4           | 123.6 mm             | 154.5 mm                  | 177.6 mm            | 191.6 mm                |   |
| 5           | 149.4 mm             | —                         | —                   | —                       |   |

<sup>†</sup> Tower Height (H) with top unscrewed approximately 3.5 mm to allow sound to escape

Accessories are listed on pages 61



## CL50 Column Lights

---

- Rugged, cost-effective, and easy-to-install multicolor indicators
- Illumination provides easy-to-see operator guidance and equipment status indication at long distances
- One-, two-, or three-color models available
- The LED light sources provide long life with low power consumption
- 100 to 240 V ac operation or 18 to 30 V dc operation
- Compact devices are completely self-contained—no controller needed—and IEC IP67 rated
- Immune to EMI and RFI interference
- No assembly required

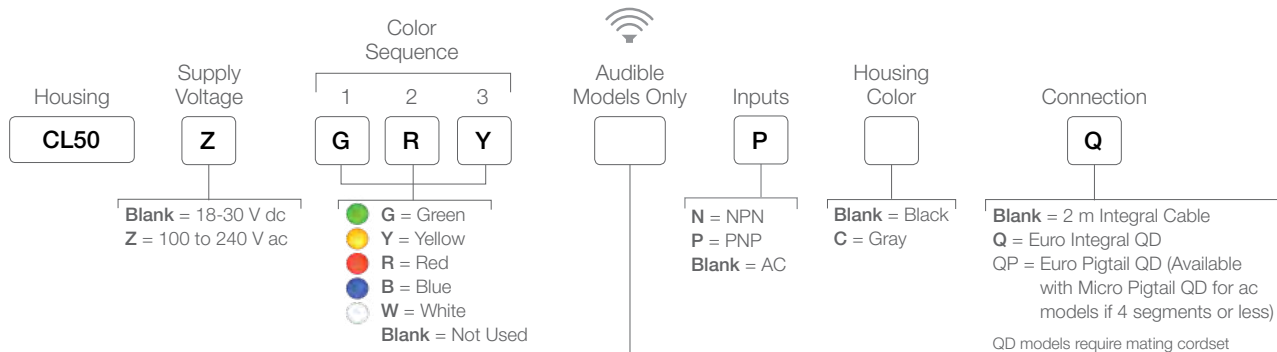

- Blank = None (IP67)
- A = Audible (IP50)
- ALS = Sealed Audible Continuous Tone
- ALS3 = Sealed Audible Pulsed Tone
- ALS4 = Sealed Audible Staccato Tone
- AOS = Omni-Directional Sealed Audible Continuous Tone
- AOSI = Omni-Directional Sealed Audible Continuous Tone–Intensity Adjust
- AOS3 = Omni-Directional Sealed Audible Pulsed Tone
- AOS3I = Omni-Directional Sealed Audible Pulsed Tone–Intensity Adjust
- AOS4 = Omni-Directional Sealed Audible Staccato Tone
- AOS4I = Omni-Directional Sealed Audible Staccato Tone–Intensity Adjust

**Supply Voltage** | 12 to 30 V dc or 21 to 27 V ac  
100 to 240 V ac

**Construction** | Bases and Covers: ABS  
Light Segment: Polycarbonate

**Environmental Rating** | General-Purpose and Sealed Audible: IEC IP67  
Standard Audible: IEC IP50

**Operating Temperature** | General-Purpose:  
–40° to +50° C (–40° to +122° F)  
Standard and Sealed Audible:  
–20° to +50° C (–4° to +122° F)

**Certifications** |  



Laser  
Marking  
Available

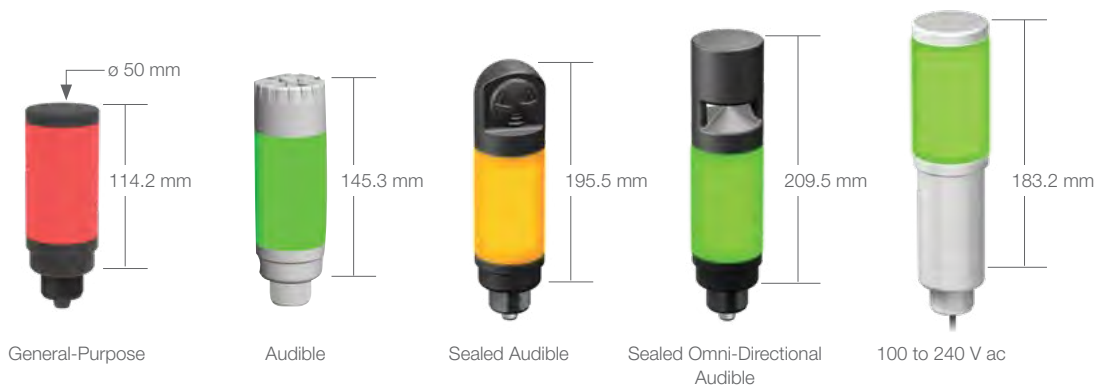

Accessories are listed on pages 61

## Cordsets for DC Models

### 4-Pin M12/Euro-Style

use with 3-color models

Straight connector models listed; for right-angle models, add RA to the end of model number (example, MQDC-406RA)

### 5-Pin M12/Euro-Style

use with 4-color models

Straight connector models listed; for right-angle models, add RA to the end of model number (example, MQDC1-506RA)

### 8-Pin M12/Euro-Style

use with 5+ -color models

Straight connector models listed; for right-angle models, add RA to the end of model number (example, MQDC2S-806RA)



**MQDC-406**  
2 m (6.5')  
**MQDC-415**  
5 m (15')  
**MQDC-430**  
9 m (30')

**MQDC1-506**  
2 m (6.5')  
**MQDC1-515**  
5 m (15')  
**MQDC1-530**  
9 m (30')

**MQDC2S-806**  
2 m (6.5')  
**MQDC2S-815**  
5 m (15')  
**MQDC2S-830**  
9 m (30')

## Mounting Brackets



SMB30MM



SMB30A



SMBAMS30P



SMB30RAVK

## Cordsets for AC Models

### 4-Pin Micro-Style

Straight connector models listed; for right-angle models, add RA to the end of model number (example, MQAC2-406RA)

### 5-Pin Micro-Style

Straight connector models



**MQAC2-406**  
2 m (6.5')  
**MQAC2-415**  
5 m (15')  
**MQAC2-430**  
9 m (30')

**MQAC2-506**  
2 m (6.5')  
**MQAC2-515**  
5 m (15')  
**MQAC2-530**  
9 m (30')

## Sealed Right-Angle Brackets



LMBE12RA



LMB30RA



LMBE12RAC



LMB30RAC



## Controller

**LC80T**  
5 Toggle switches  
ON-OFF-FLASH function

**LC80R**  
12-Position rotary  
switches ON-OFF-FLASH  
function



## Laser Marking

Light sections can be permanently marked with custom text or images



# Accessories

## Elevated Mount System (for TL70)

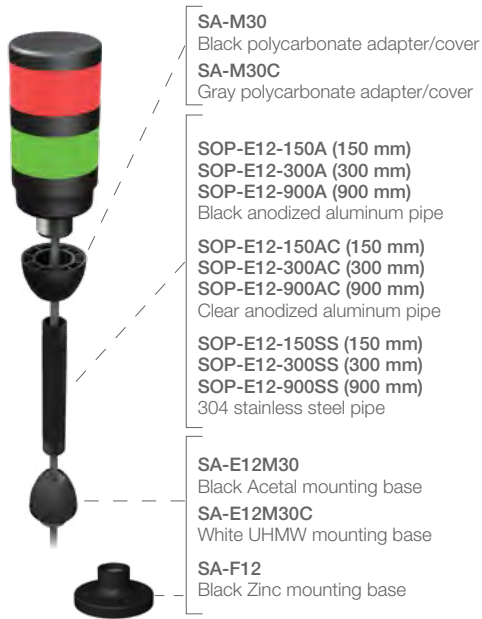

## Elevated Mount System (for other models)

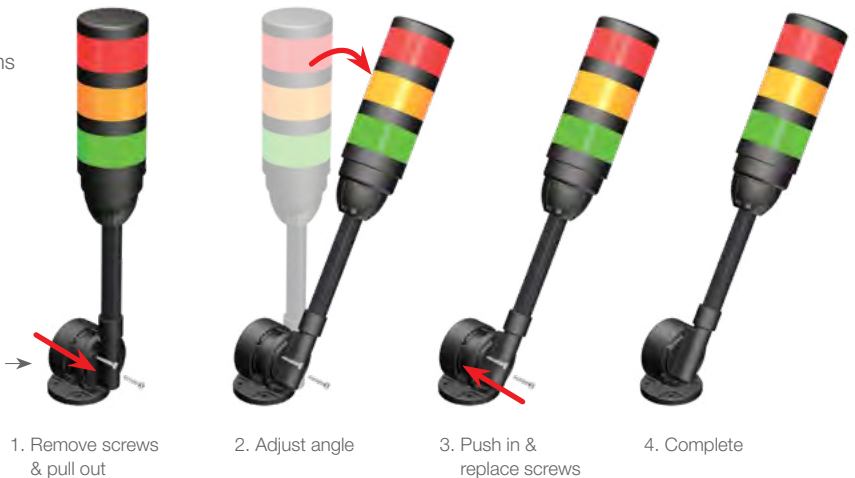

Additional accessories are available at [bannerengineering.com](http://bannerengineering.com)