

**BALLUFF**

Products and  
Services

QUALITY  
MEETS PROGRESS

 *innovating automation*





Balluff GmbH, Headquarters, Neuhausen a.d.F., Germany – illustration new corporate design

As a leading sensor specialist and system provider with a company tradition of over 90 years, Balluff GmbH has been a recognized partner for factory automation and industrial hydraulics for decades. We have a strong global presence with 62 sales branches and representative offices as well as nine production sites on all continents. The corporate headquarters in Neuhausen a.d.F. is located near Stuttgart.

Balluff offers a wide array of products with varied operating principles: high-quality sensors and systems for position measurement and identification, as well as sensors to detect objects and measure fluids. The full-range assortment includes optimal network and connection technology and a comprehensive line of accessories.

We offer innovative, first-class products tested in our own accredited laboratory and maintain certified quality management per with DIN EN 9001:2015. Our technology speaks for itself in international applications since it also meets regional standards.

Balluff stands for application-specific customer solutions, comprehensive services, individual consultation and prompt service. Our staff of more than 3300 employees is committed to providing outstanding service worldwide.

# Smart Safety

## Simply safe

### Safety with Balluff quality

Automation requires safety. And safety is based on reliability. Balluff quality guarantees ultra-reliable solutions. Thus the Balluff safety concept also consists of products and solutions that fulfill their tasks over the course of years with the same reliability and precision. But we are not satisfied to stop at that. Our goal is to design the processes of our customers to be more functional, efficient and accurate, and to always offer the best solution for their requirements.

### Balluff safety components

Our safety concept includes a constantly growing number of products and components that minimize danger for people and production systems. These components are easy to integrate into your control system.

### One-of-a-kind: Safety over IO-Link

To increase the efficiency of safety concepts and integrate them into the control system, we have developed the Balluff Safety Hub. The first integrated safety solution that uses IO-Link! Safety over IO-Link is easy to integrate, responds quickly and can replace the control cabinet.

Safety over IO-Link combines automation and safety technology. IO-Link handles communication down to the last meter and provides both sensor/actuator details as well as secure information. IO-Link handles communication down to the last meter and provides both sensor/actuator details as well as secure information – state-of-the-art, with the usual Balluff quality and all from a single source.

### Freedom to change your system down to the last minute

The standardization of topology and safety components means you can easily and quickly adapt your application to changing requirements at any time. It is extremely flexible down to the last minute.

### Safety

Safety over IO-Link via I/O Module	4
Safety Light Curtains	6
Safety Switches with or without Guard Locking	8
Emergency Stop Device	10
Inductive Safety Sensors	12
Non-contact, magnetically coded safety switch	14
Compact, non-contact RFID safety sensors	16

### IO-Link

Actuator hubs for single-channel monitoring	18
---	----

### Profinet

8-port IO-Link Master	20
-----------------------	----

### SmartLight

22

### Connectors and Cables

26

### Accessories

36



# Safety over IO-Link via I/O Module

## Recording and communicating signals reliably

### A single module for automation and safety technology

In the new BNI IOF I/O module, IO-Link provides both details of sensors/actuators and secure information, which means that you can get the best of both worlds using a single system. The solution arranges integration of the safety technology to the sensor level in the simplest way possible.

Here, the I/O module only has to be linked to the existing system via the IO-Link master and almost any safety device can be connected. The parameters are configured centrally using the controller to which the IO-Link master previously transmitted all safety-relevant information.

### Benefits

- IO-Link provides a single infrastructure for automation and safety technology up to PLe/SIL3
- Cost savings thanks to uniform M12 single-ended cordsets
- Reduction in IP address space
- Safe auxiliary equipment can be connected directly using standardized wiring concept
- Low maintenance costs when service is needed – diagnosis is thorough and component replacement simple

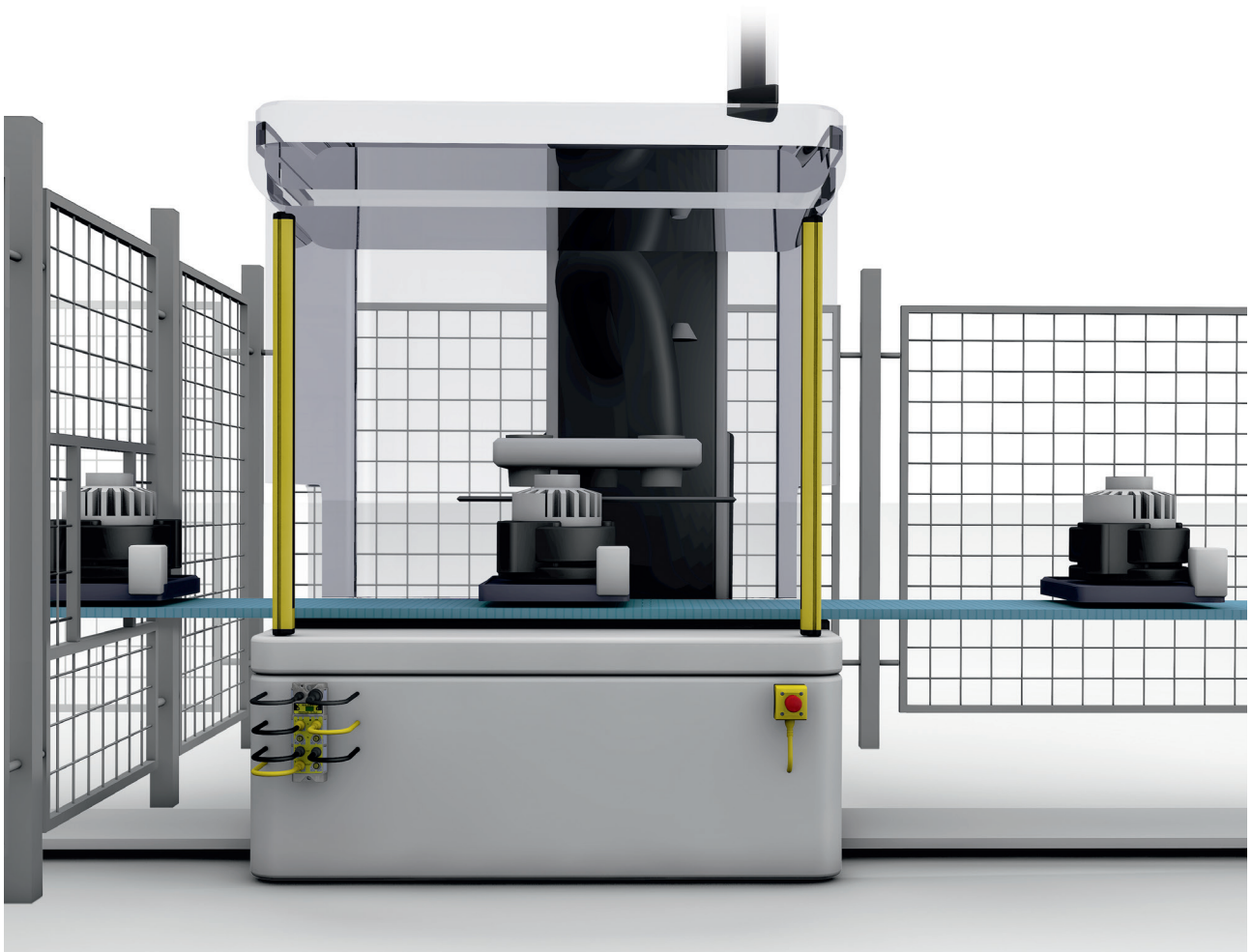

Safety technology and automation combined





Type	Safety I/O module
	<b>BNI0098</b>
Device interface	Profisafe over IO-Link
Baud rate	COM2 (38.4 kbaud)
Response time	Max. 20 ms
PL (EN ISO 13849-1)/SIL CL (EN/IEC 62061)	PLe/SIL CL 3
Power supply	19,2...30 V
Supply voltage (without connected peripherals)	< 180 mA
Max. total current/Sensor supply	4,8 A
Total current $I_{Actuator}$	8 A
Degree of protection per IEC 60529	IP67 (with connectors)
Ambient temperature	-5...+55 °C
Number of inputs/safe inputs	2/12
Number of outputs/safe outputs	2/2
Cable length for inputs/outputs	Max. 30 m
Housing material	Nickel-plated die-cast zinc
Approvals	TÜV, UL (in preparation)

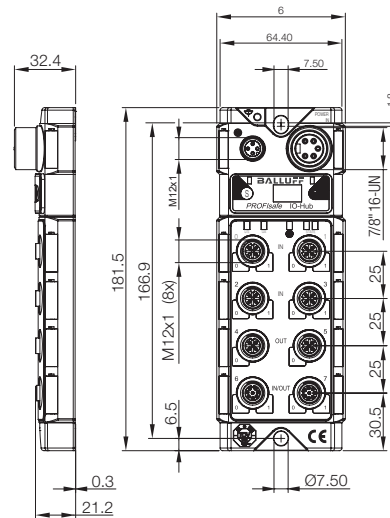

# Safety Light Curtains

## Economical hazardous area security for personal protection

### In the interest of all employees involved in production

BLG safety light curtains from Balluff are photoelectric, electro-sensitive protective equipment. They detect fingers, hands and other body parts and are used in work areas where machines present potential hazards. They stop hazardous movements in these areas.

The BLG device consists of an emitter and a receiver and covers the protected area using an infrared field.

If an object breaks the beam emitted by the transmitter unit, both switching outputs (OSSD) on the receiver are deactivated immediately, which causes the connected machine to stop.

### Benefits

- Omission of safety fences for better use of the space available
- Rapid interaction between operator and machine
- High manipulation protection
- For finger, hand and body detection
- PLe/SIL 3

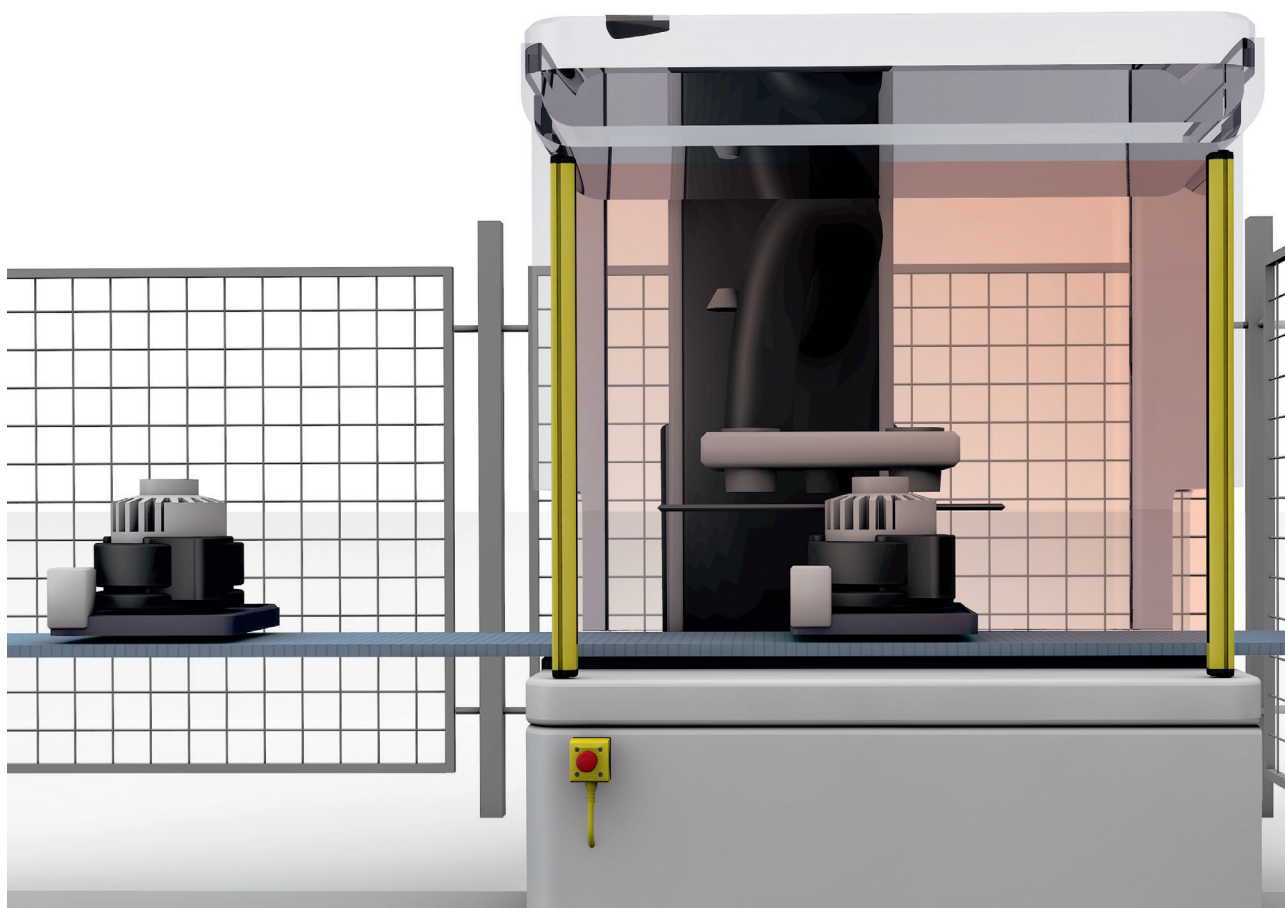

Photoelectric light curtains safeguard hazardous areas by detecting people



Application for		Finger protection	Hand protection	Body protection
Range		< 6 m	< 19 m	< 50 m
Response time		11...50 ms	9...28 ms	14...16 ms
Resolution		14 mm	30 mm	> 315 mm
Opto-electronic protective device	150 mm	<b>BLG000A</b>	<b>BLG000T</b>	
	300 mm	<b>BLG000C</b>	<b>BLG000U</b>	
	450 mm	<b>BLG000E</b>	<b>BLG000W</b>	
	515 mm			<b>BLG0006</b>
	600 mm	<b>BLG000F</b>	<b>BLG000Y</b>	
	750 mm	<b>BLG000H</b>	<b>BLG000Z</b>	
	815 mm			<b>BLG0007</b>
	900 mm	<b>BLG000J</b>	<b>BLG0010</b>	
	915 mm			<b>BLG0008</b>
	1050 mm	<b>BLG000K</b>	<b>BLG0011</b>	
	1200 mm	<b>BLG000L</b>	<b>BLG0012</b>	
	1215 mm			<b>BLG0009</b>
	1350 mm	<b>BLG000R</b>	<b>BLG0013</b>	
1500 mm	<b>BLG000M</b>	<b>BLG0014</b>		
1650 mm	<b>BLG000N</b>	<b>BLG0015</b>		
1800 mm	<b>BLG000P</b>	<b>BLG0016</b>		
Switching output		OSSD	OSSD	OSSD
PL (EN ISO 13849-1)/SIL CL (EN/IEC 62061)		PLe/SIL CL 3	PLe/SIL CL 3	PLe/SIL CL 3
Connection	Emitter	M12 male, 4-pin	M12 male, 4-pin	M12 male, 4-pin
	Receiver	M12 male, 5-pin	M12 male, 5-pin	M12 male, 5-pin

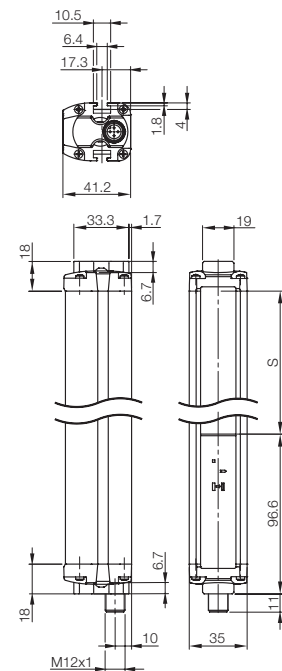
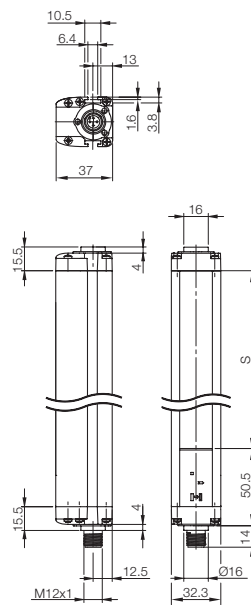



# Safety Switches with or without Guard Locking

## Robust, reliable access protection

### Adapted to a wide range of requirements

Safety switches with a separate actuator are protection devices which simultaneously provide personal and machine protection. Together with a machine controller and an isolating protection device they secure the hazardous area against access. Depending on requirements, BID F-101 safety switches can be used without guard locking, with mechanical guard locking or with electrical guard locking.

### Benefits

- Robust metal housing with status indicator
- Rotary actuator button with two insertion openings that can be adjusted in 90° increments
- Pluggable 5-pin or 8-pin M12 connection
- Guard locking device available with open or closed current principle
- High holding forces of up to 2500 N



---

Guard locking

---

Escape release  
Door contacts

---

Magnetic contacts  
Connection

---



BID F101 safety switches in interlocking and guard locking device



BID0005	BID0004	BID0002	BID0003	BID0001
	mechanical (rest current)	mechanical (rest current)	electrical (operating current)	electrical (operating current)
2 positive opening contacts and 1 × NO	1 × NO	1 × NO	1 × NO	1 × NO
	2 × positive opening contacts	2 × positive opening contacts	2 × positive opening contacts	2 × positive opening contacts
M12 male, 5-pin	M12 male, 8-pin	M12 male, 8-pin	M12 male, 8-pin	M12 male, 8-pin

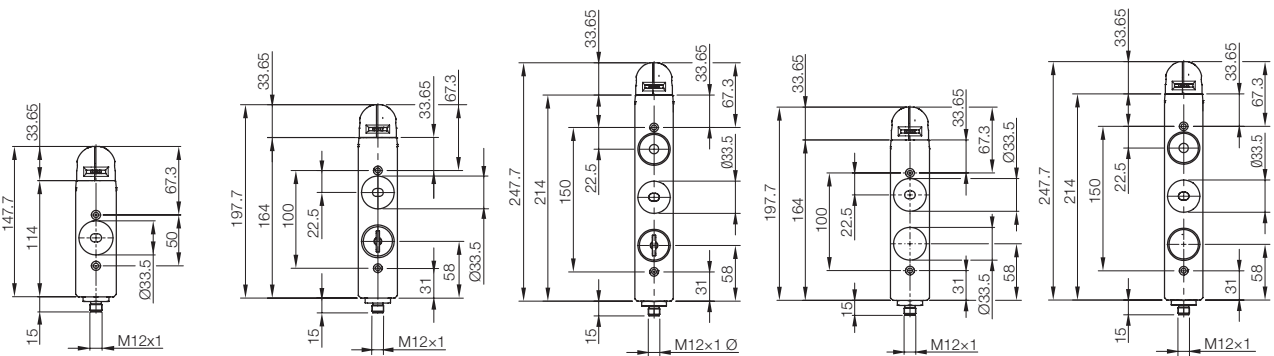

### Wiring diagrams

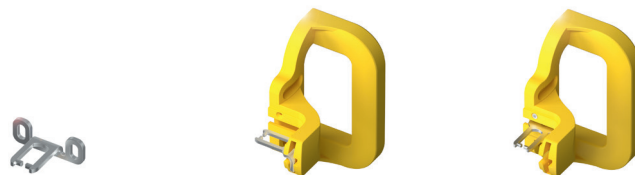
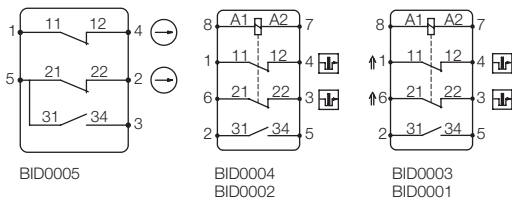

Type	Actuator	Actuator	Actuator
	<b>BAM0270</b>	<b>BAM0271</b>	<b>BAM0272</b>
Description	Actuator, angled	Actuator, swinging doors handle	Actuator, sliding doors handle
Material	Actuator, angled	Aluminum die-cast, painted, stainless steel actuator	Aluminum die-cast, painted, stainless steel actuator

# Emergency Stop Device

In compact housing, easy to install on various machines and equipment

## Emergency stop device with rapid response time

The emergency stop device is an additional safety feature in automated systems that must function correctly at all times. The emergency stop function issues a command to stop the system immediately in order to protect personnel. The device must be visible and always easily accessible in order to enable stopping in emergency situations.

## Benefits

- Reliable disconnection of the power supply
- Positive opening as per IEC 60947-5-1
- Pluggable 5-pin M12 connection
- Mushroom pushbutton with rotary release
- High degree of protection against dust and water

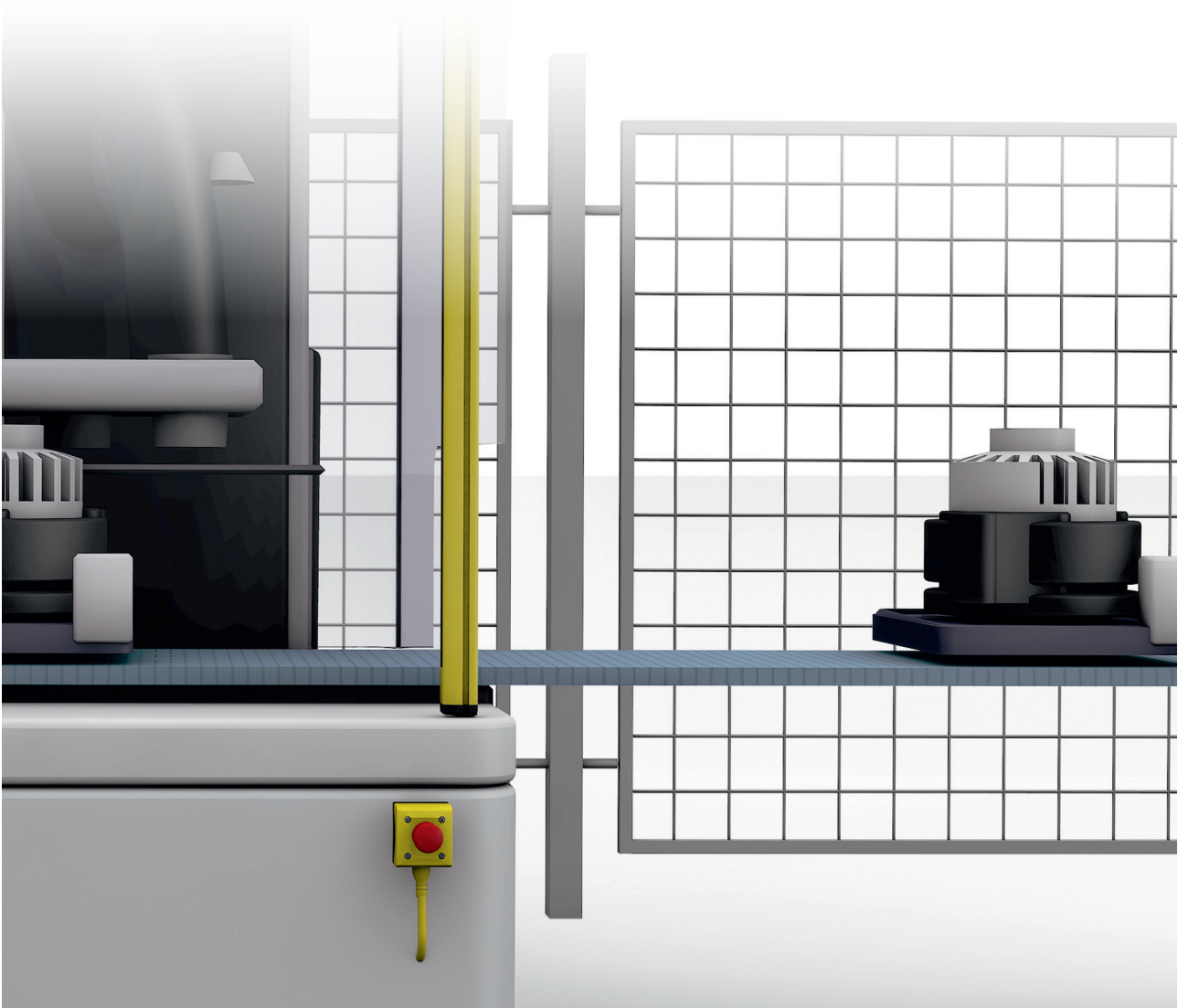

Installed with minimal effort: emergency stop in compact form





<b>BAM02HA</b>	
Contacts	2 × positive opening contacts
Switching voltage	24 V AC/DC
Rated operating voltage $U_o$	AC15 24 V
	DC13 24 V
Rated operating current $I_o$	AC15 3 A
	DC13 3 A
Mechanical service life	60000 switching operations
Switching actuation force	40 N
Characteristic safety values B10d	1.0E+05 switching operations
Ambient temperature	-25...+70 °C
Degree of protection per IEC 60529	IP65
Housing material	Plastic
Dimensions	72 × 106 × 80 mm
Connection	M12 male, 5-pin

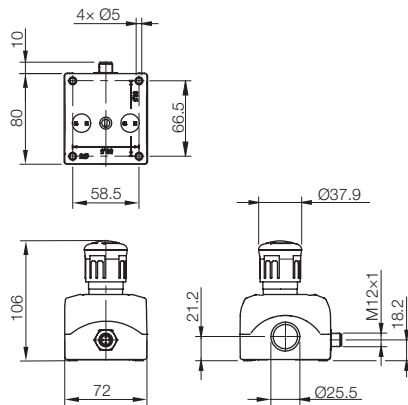

# Inductive Safety Sensors

## Reliably detect metal – rugged and wear-free

### Protection for people and equipment

BES inductive safety sensors protect people and equipment by detecting the approach of metallic objects without contact, thereby providing the necessary safety signals for position and end-of-travel.

Direct detection of metallic tool holders is simple and reliable with these sensors. Unlike traditional safety switches, these require no special target. Instead, these safety switches can be connected to any desired safety processor: safety relays, programmable logic modules, or safety controllers. A standard M12 plug connection is all you need for wiring.

Another feature: our sensors are so flexible that they can also be used as pulse transmitters for counting tasks or for stop monitoring.

### Benefits

- Reliably detect end-of-travel, speed and stop condition without contact and wear-free
- Compact and common form factors from M12 to Q40
- Simple connection using M12 plugs
- Easy to link to any processor using OSSD outputs

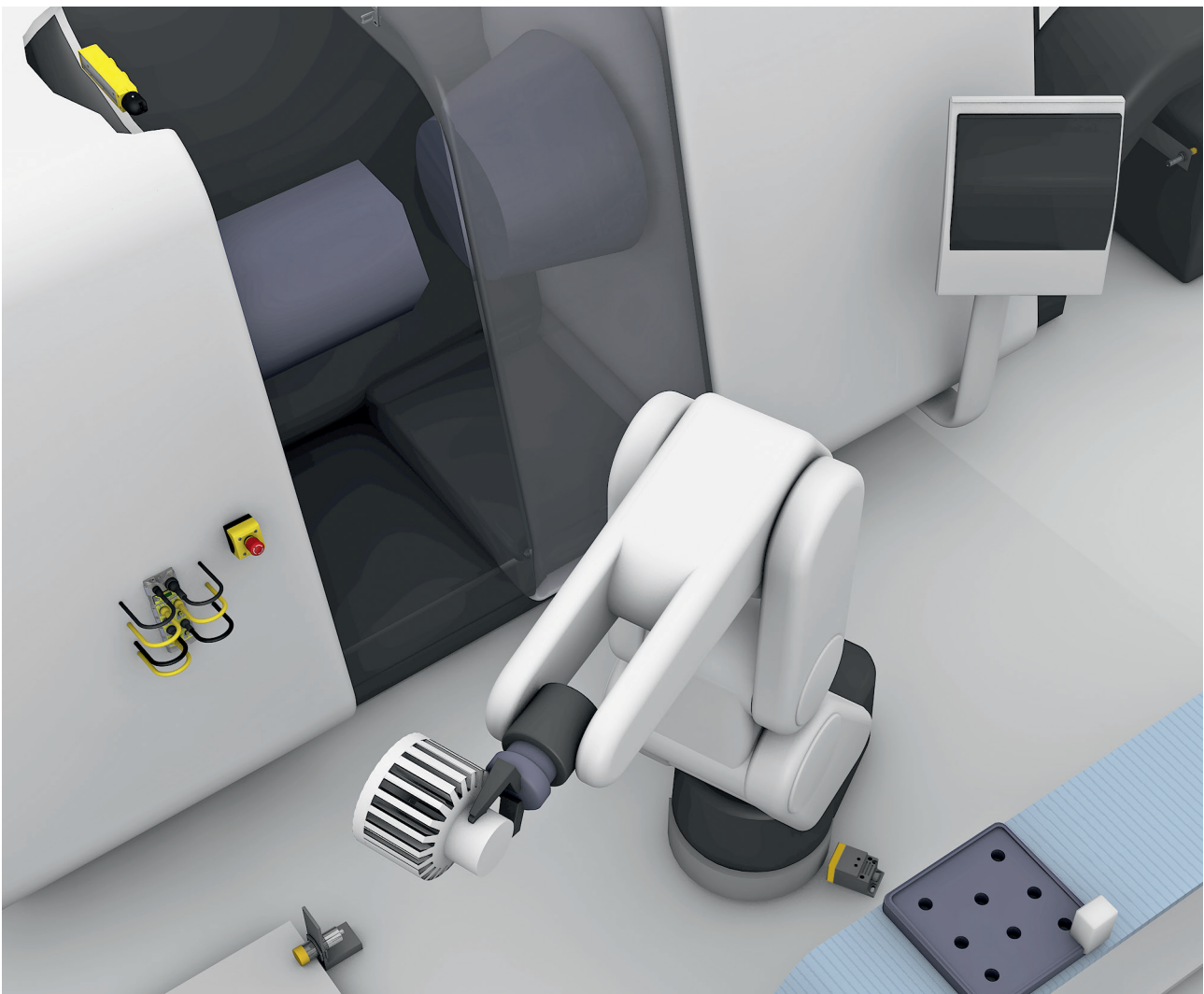

Inductive safety sensors protect people and equipment. They can be connected to any safety processor.



	<b>BES0574</b>	<b>BES0575</b>	<b>BES0576</b>	<b>BES0577</b>
Performance Level/SIL	d/2	d/2	d/2	e/3
Safety category	2	2	2	4
Dimension	M12 × 70 mm	M18 × 70.5 mm	M18 × 70 mm	M30 × 80 mm
Installation	non-flush	non-flush	flush	non-flush
Switching distance	0.5...4 mm	1...8 mm	1...5 mm	6...12 mm
Degree of protection	IP67	IP67	IP67	IP68, IP69K
Switching output	2 × OSSD	2 × OSSD	2 × OSSD	2 × OSSD
Ambient temperature	-25...+70 °C	-25...+70 °C	-25...+70 °C	-25...+70 °C
Housing material	1.4404 stainless steel	1.4571 stainless steel	Brass	1.4404 stainless steel
Connection	M12 male, 4-pin	M12 male, 4-pin	M12 male, 4-pin	M12 male, 4-pin

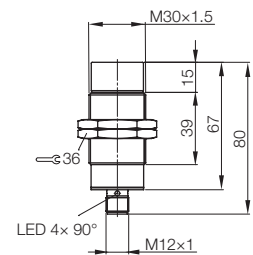
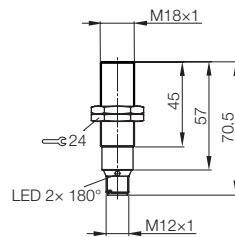
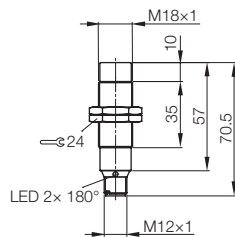
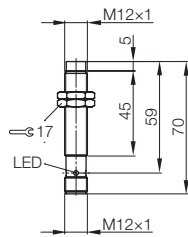

	<b>BES0578</b>	<b>BES0579</b>	<b>BES057A</b>	<b>BES057C</b>
Performance Level/SIL	d/2	d/2	e/3	e/3
Safety category	2	2	4	4
Dimension	M30 × 70 mm	M30 × 70 mm	40 × 40 × 66 mm	40 × 40 × 66 mm
Installation	non-flush	flush	flush/non-flush	non-flush
Switching distance	1...15 mm	1...10 mm	10...15 mm	4...20 mm
Degree of protection	IP67	IP67	IP67	IP67
Switching output	2 × OSSD	2 × OSSD	2 × OSSD	2 × OSSD
Ambient temperature	-25...+70 °C	-25...+70 °C	-25...+70 °C	-25...+60 °C
Housing material	1.4571 stainless steel	Brass	Die-cast zinc	Die-cast zinc
Connection	M12 male, 4-pin	M12 male, 4-pin	M12 male, 4-pin	M12 male, 4-pin

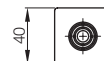
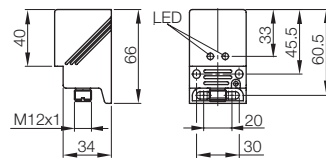
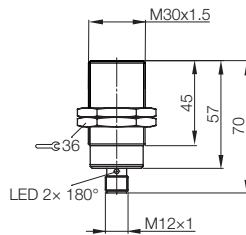
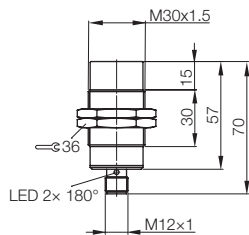



# Non-contact, magnetically coded safety switch

## Rugged, proven technology

### Wear-free because of contact-free operating principle

Non-contact magnetically coded safety switches are outstanding for monitoring guard doors – especially in environments where contamination or dust is expected. The non-contact operating principle means they are insensitive to mechanical play, for example, when doors settle or are imprecisely guided. This makes our safety switches simple to install.

The proven magnetic technology with intelligent arrangement of the reed contacts in the switch housing offers high tamper security and reduces the risk of bypassing the safety function. With separate processing electronics the safety switch can be used for applications up to PLe/SIL 3. With the optional spacer you can even install the safety switch in a ferromagnetic environment.

### Benefits

- Insensitive to contamination because of contact-free operating principle
- Standardized M12, 5-pin connection technology saves money
- Suitable for direct connection to safe Balluff IO-Link I/O module
- Simple connection to any safety controller
- Magnetic operating principle, reed contact



Non-contact, magnetically coded safety switches monitor guard doors.

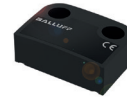

	<b>BID0007</b>	<b>BID000T</b>
Operating principle	Reed safety switch	Magnetically coded actuator
Coding level	low	
Performance Level/SIL	up to PL e with suitable logic unit per IEC 60947-5-3	
Degree of protection	IP67	
Switching output	2 × normally closed	
Switching voltage	max. 24 V DC	
Switching current	max. 10 mA	
Ambient temperature	-25...+70 °C	-25...+70 °C
Housing material	Fiberglass reinforced thermoplastic	Fiberglass reinforced thermoplastic
Connection	Cable with connector M12, 5-pin, A-coded	

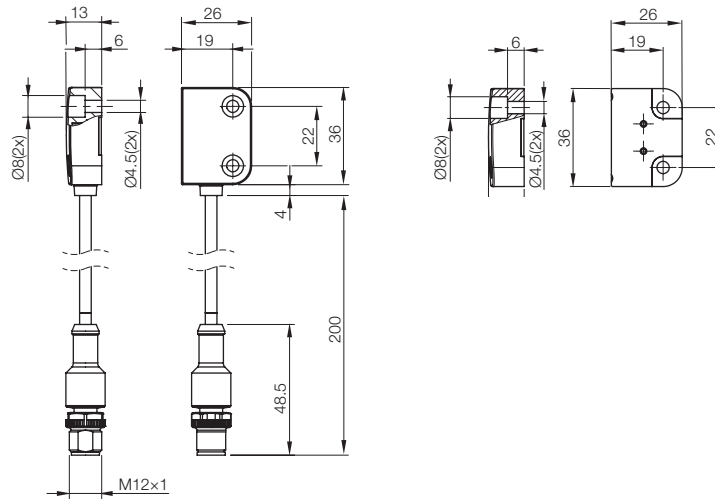

# Compact, non-contact RFID safety sensors

## Tamper resistant, wear-free access protection – with options for installation and utilization

### Tamper-proof RFID operating principle

Non-contact, transponder-coded safety sensors are ideal for monitoring guard doors and flaps. These enable high coding levels and therefore high tamper protection, since the sensor uniquely identifies the passive RFID transponder.

The sensor is ideal especially in environments where high levels of dust or contamination are expected. The large operating range of the sensor makes it insensitive to vibration and mechanical play on the safety guard, for example, when doors settle or are poorly aligned. The large operating range also simplifies your installation. The compact size provides additional flexibility when integrating. It's easy to use the devices in applications up to PLe and SIL 3 thanks to the built-in safety logic and the OSSD output stage.

### Benefits

- Tamper-proof RFID operating principle available with low or high coding level
- Vibration-proof and insensitive to contamination thanks to non-contact operating principle
- Simple, time-saving installation with generous operating range
- Standardized M12, 5-pin connection technology saves money
- Suitable for direct connection to safe Balluff IO-Link I/O module

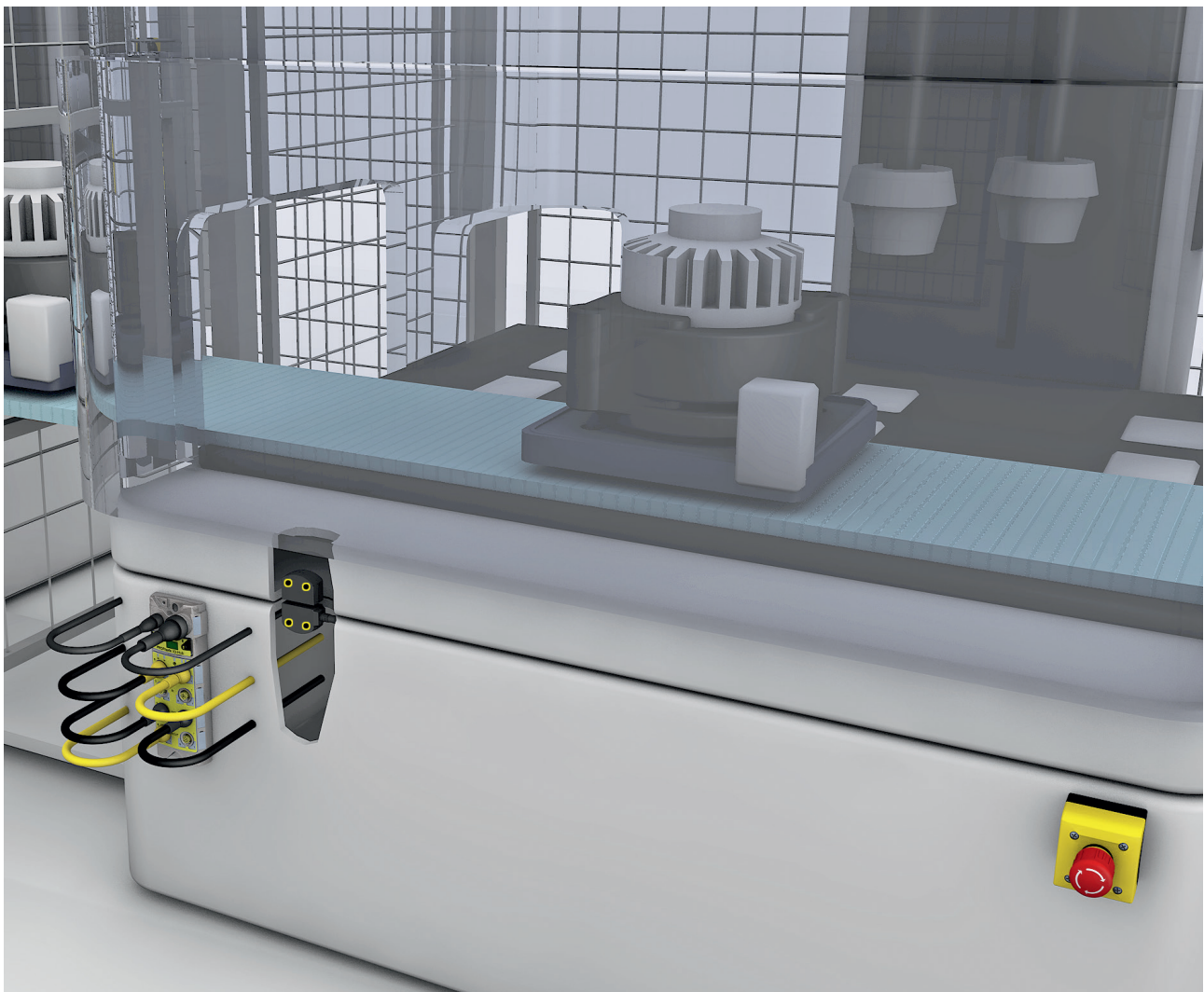

Non-contact, transponder-coded safety sensors monitor guard doors and offer high tamper protection.





	BID0008	BID0009	BID000U	BID000W
Operating principle	RFID safety sensor	RFID safety sensor	RFID transponder	RFID transponder
Coding level	low	high		
Performance Level/SIL	e/3	e/3		
Safety category	4	4		
Degree of protection	IP65/IP67	IP65/IP67		
Switching output	2 × OSSD	2 × OSSD		
Ambient temperature	-25...+65 °C	-25...+65 °C	-25...+65 °C	-25...+65 °C
Housing material	Thermoplastic resin	Thermoplastic resin	Thermoplastic resin	Thermoplastic resin
Connection	Cable with connector M12, Cable with connector 5-pin, A-coded			
		M12, 5-pin, A-coded		

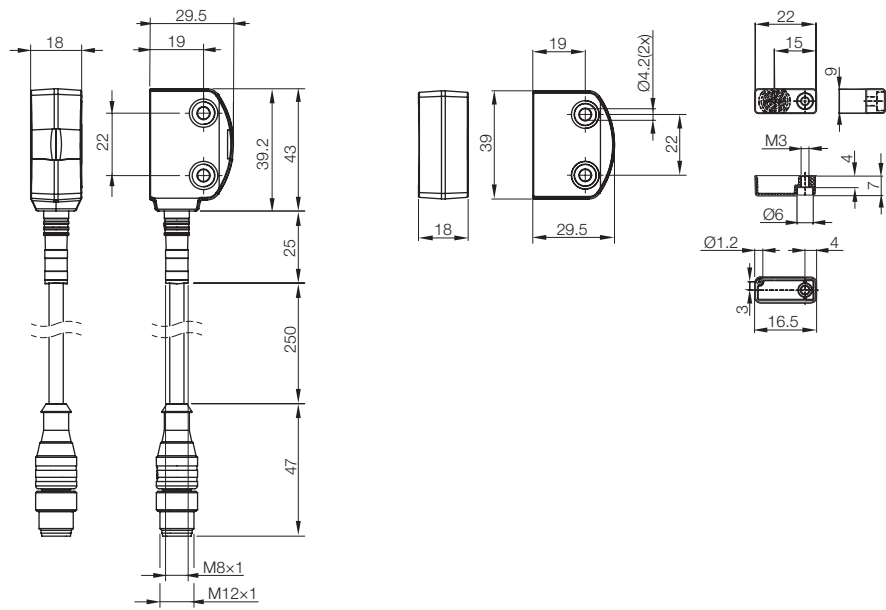

# IO-Link

## Actuator hubs for single-channel monitoring

### Safety for the network/system integration

When standard I/O and safety I/O need to be integrated into a fieldbus topology, the topic of safety plays an ever greater role.

IO-Link actuator hubs enable safe shutdown (SIL 2, Kat. 3, PL d, Cat. 3, PL d).

The I/O block is divided into two galvanically isolated segments so that you can implement two separately switching safety circuits using one module. This expands the functionality of the IO-Link system concept considerably. It meets the requirements for a holistic approach and simultaneously reduces the number of components and guarantees simpler installation.

### Benefits

- Robust housing
- Powerful inputs
- Powerful outputs
- Extended temperature range
- Modules with reliable deactivation mechanism



IO-Link
Design
Supply voltage $U_S$
Function indicator IO-Link RUN
Power-on indicator
Connection: IO-Link
Connection: I/O ports
Connection $U_S$
Connection $U_A$
No. of I/O ports
Number of outputs
Configurable
Single-channel monitoring
Number of output circuits
Outputs per output circuit
Single-channel monitoring
Max. load current actuators/channel.
Port status indicator
Total sensor current
Total actuator current
Degree of protection as per IEC 60529
Operating temperature $T_a$
Storage temperature
Fastening
Dimensions
Housing material
Approval
<b>IO-Link</b>
Max. cycle time
IO-Link process data length
Displays      Communication
Error





Device	Device	Device	Device
2 segments, each 4 × DO	2 segments, each 8 × DO	2 segments, each 4 × DO	2 segments, each 8 × DO
<b>BNI0033</b>	<b>BNI0034</b>	<b>BNI003W</b>	<b>BNI003Y</b>
18...30 V DC	18...30 V DC	18...30 V DC	18...30 V DC
Green LED	Green LED	Green LED	Green LED
Green LED	Green LED	Green LED	Green LED
M12, A-coded, male	M12, A-coded, male	M12, A-coded, male	M12, A-coded, male
M12, A-coded, female	M12, A-coded, female	M12, A-coded, female	M12, A-coded, female
7/8", male, 5-pin	7/8", male, 5-pin	7/8", male, 5-pin	7/8", male, 5-pin
7/8", male, 5-pin	7/8", male, 5-pin	7/8", male, 5-pin	7/8", male, 5-pin
8	8	8	8
8	16	8	16
No	No	No	No
No	No	Yes	Yes
2	2	2	2
4	8	4	8
No	No	Yes	Yes
2 A	2 A	2 A	2 A
Yellow/red LED	Yellow/red LED	Yellow/red LED	Yellow/red LED
9 A	9 A	9 A	9 A
9 A	9 A	9 A	9 A
IP67 (when screwed into place)	IP67 (when screwed into place)	IP67 (when screwed into place)	IP67 (when screwed into place)
-5...+70 °C	-5...+70 °C	-5...+70 °C	-5...+70 °C
-25...+70 °C	-25...+70 °C	-25...+70 °C	-25...+70 °C
2 mounting holes	2 mounting holes	2 mounting holes	2 mounting holes
181 × 68 × 36.9 mm	181 × 68 × 36.9 mm	181 × 68 × 36.9 mm	181 × 68 × 36.9 mm
Nickel-plated die-cast zinc	Nickel-plated die-cast zinc	Nickel-plated die-cast zinc	Nickel-plated die-cast zinc
TÜV, UL	TÜV, UL	TÜV, UL	TÜV, UL

<b>Version 1.0</b>	<b>Version 1.0</b>	<b>Version 1.0</b>	<b>Version 1.0</b>
2.5 ms	5 ms	15 ms	20 ms
1 output byte	2 output byte	3 input bytes/1 output byte	5 input bytes/2 output bytes
Green LED, pulsing	Green LED, pulsing	Green LED, pulsing	Green LED, pulsing
Red LED	Red LED	Red LED	Red LED

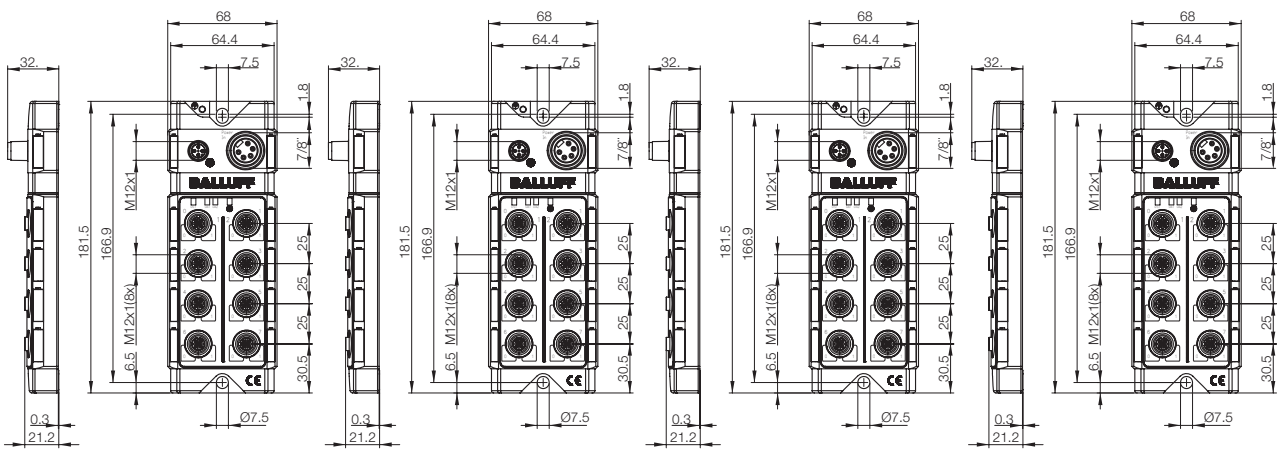

**Profinet modules with display, integrated switch, and Web server**

The Profinet IO-Link Master interface is ideal for high-performance applications.

**More data volume and faster communication than traditional fieldbus systems**

Profinet is increasingly becoming the communications medium of the future for mechanical and plant engineering and in some areas has already incrementally replaced Profibus. Based on Ethernet, communication over Profinet is significantly faster and the data volume much greater than with traditional fieldbus systems and allows incorporation of time-critical drive technology. Profinet is quick to install and integrates easily into existing networks. In addition to time savings and considerable cost savings comes the added benefit of ease of operation.

**Exclusively from Balluff**

Especially operator-friendly are Balluff Profinet modules with display, by which you can block IP addresses and protect them from unintended changes. Only Balluff offers you this function which you can use to simplify maintenance and increase safety.

**IO-Link**

The IO-Link communication standard is an integral part of our Profinet modules. The modules with IO-Link functionality include up to eight IO-Link master ports that can be configured and used fully independently of one another. All IO-Link ports support COM1, COM2, COM3 (3-wire only) as well as SIO mode. The IO-Link ports also include an additional input or input/output via pin 2. With the module having four IO-Link master ports you get four additional standard I/O ports with eight inputs or eight freely configurable inputs/outputs for standard sensors and actuators up to 2 A.

**Integrated 2-port Ethernet switch**

All Profinet modules offer an integrated 2-port Ethernet switch. This permits line topology without having to add a separate external switch. Diagnostics and parameterizing can be performed using the integrated Web server.





Fieldbus	Profinet
Design	8x IO-Link, 16x DI/DO
	<b>BNI005H</b>
Supply voltage $U_s$	18...30 V DC
Function Indicator	BUS/RUN
Indicator/input	Display/pushbutton
Module status indicator: Mod LED	Yes
Network status indicator: Net LED	Yes
Port status indicator	Black, red, yellow
Fieldbus connection	M12, D-coded, female
AUX power connection	7/8", male, 5-pin
Connection: I/O ports	M12, A-coded, female
No. of I/O ports	8
Number of inputs	Max. 16 PNP
Number of outputs	Max. 16 PNP
Configurable inputs/outputs	Yes
Max. load current for sensors/channel	200 mA
Max. load current, output	1.2 A/2 A
Port status indicator (signal status)	Yellow LED
Port diagnostic indicator (overload)	Red LED
Total actuator current	$\leq 9$ A
Total sensor current	$\leq 9$ A
Degree of protection as per IEC 60529	IP67 (when screwed into place)
Operating temperature $T_a$	-5...+70 °C
Storage temperature	-25...+70 °C
Fastening	2 mounting holes
Dimensions	224 x 68 x 37.9 mm
Housing material	Nickel-plated die-cast zinc
<b>IO-Link</b>	<b>Version 1.1</b>
No. of IO-Link master ports	8 x master
Operating modes (3-wire)	SIO, COM 1, COM 2, COM 3
Displays	Communication
	Error
Max. load current IO-Link device	1.2 A

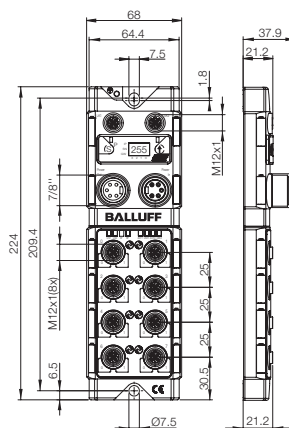



# IO-Link Devices

## SmartLight

### One light. Three functions. Unlimited uses,

The SmartLight is the first LED signal stack light with IO-Link interface. Its color spectrum allows you to represent operating states in detail. Its color spectrum allows you to represent operating states in detail – and even read trends and changes in physical factors. For this the SmartLight provides three modes:

- Stack light mode: Display of different color signals in up to five different segments
- Level mode: Color display for representing measurement values such as level, position, temperature, etc.
- Running light mode: Automatic running light with freely configurable foreground and background color

### Ease of handling: Mode changes on-the-fly

Modes can be changed on-the-fly. Even colors can be changed while running. This makes the SmartLight unique.

You configure the SmartLight simply from the controller by bit-addressing the IO-Link address range. Different colors can be assigned with a few commands, without having to mechanically change the LED stack lights.

### Zones and colors can be defined individually

These colors and zones can be specified individually in terms of number, size and color definition. These colors and zones can be specified individually in terms of number, size and color definition – in contrast to previously available systems on the market.

### Quick installation

Connection and installation are easy. A 3-conductor sensor cable is all you need to quickly connect the SmartLight to your system. All the functions are now immediately available to you.

### Versions

The SmartLight is available in three sizes: 5, 3 or 1 segment(s). Even the smallest light with one segment lets you assign each color individually. Direct control makes this possible. All versions are available with a horn signal.



Maximum flexibility with level, running light and stack light mode (holder not included).



IO-Link	Device	Device	Device
Designation	SmartLight	SmartLight	SmartLight
Number of segments max.	5	3	1
	<b>BNI0072</b>	<b>BNI007F</b>	<b>BNI007T</b>
Color spectrum per segment	Red, green, yellow, blue, white	Red, green, yellow, blue, white	Red, green, yellow, blue, white
Supply voltage $U_S$	18...30 V DC	18...30 V DC	18...30 V DC
Function indicator IO-Link RUN	Green LED	Green LED	Green LED
Power-on indicator	Green LED	Green LED	Green LED
Connection: IO-Link	M12, A-coded, male	M12, A-coded, male	M12, A-coded, male
Connection $U_A$	via IO-Link interface	via IO-Link interface	via IO-Link interface
Configurable	Yes	Yes	Yes
Max. load current of actuators	0.5 A	0.25 A	0.25 A
Degree of protection as per IEC 60529	IP65	IP65	IP65
Operating temperature $T_a$	-5...+50 °C	-5...+50 °C	-5...+50 °C
Storage temperature	-25...+50 °C	-25...+50 °C	-25...+50 °C
Fastening	M18 thread	M18 thread	M18 thread
Dimensions	60 × 60 × 309 mm	60 × 60 × 213 mm	60 × 60 × 117 mm
Housing material	Plastic, transparent	Plastic, transparent	Plastic, transparent
Sound module	No	No	No

IO-Link	Version 1.1	Version 1.1	Version 1.1
Transfer rate	COM 2 (38.4 kbaud)	COM 2 (38.4 kbaud)	COM 2 (38.4 kbaud)
Cycle time	5 ms with IO-Link 1.1 Master 20 ms with IO-Link 1.0 Master	5 ms with IO-Link 1.1 Master 20 ms with IO-Link 1.0 Master	5 ms with IO-Link 1.1 Master 20 ms with IO-Link 1.0 Master
IO-Link process data length	2-byte input	2-byte input	2-byte input
Communication indicators	Green LED	Green LED	Green LED

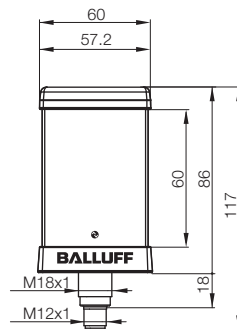
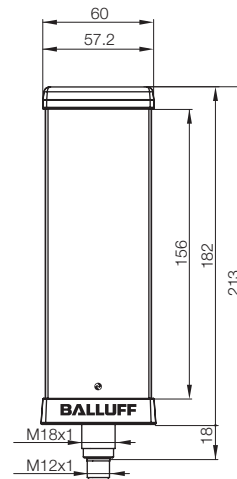
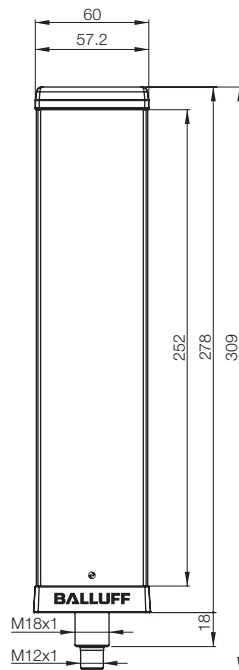

# IO-Link Devices

## SmartLight



IO-Link	Device	Device	Device
Designation	SmartLight Sound	SmartLight Sound	SmartLight Sound
Number of segments max.	5	3	1
	<b>BNI0083</b>	<b>BNI0086</b>	<b>BNI0087</b>
Color spectrum per segment	Red, green, yellow, blue, white, orange	Red, green, yellow, blue, white, orange	Red, green, yellow, blue, white, orange
Supply voltage $U_S$	18...30 V DC	18...30 V DC	18...30 V DC
Function indicator IO-Link RUN	Green LED	Green LED	Green LED
Power-on indicator	Green LED	Green LED	Green LED
Connection: IO-Link	M12, A-coded, male	M12, A-coded, male	M12, A-coded, male
Connection $U_A$	via IO-Link interface	via IO-Link interface	via IO-Link interface
Configurable	Yes	Yes	Yes
Max. load current of actuators	0.5 A	0.25 A	0.25 A
Degree of protection as per IEC 60529	IP30	IP30	IP30
Operating temperature $T_a$	-5...+50 °C	-5...+50 °C	-5...+50 °C
Storage temperature	-25...+50 °C	-25...+50 °C	-25...+50 °C
Fastening	M18 thread	M18 thread	M18 thread
Dimensions	60 × 60 × 330.5 mm	60 × 60 × 234.5 mm	60 × 60 × 138.5 mm
Housing material	Plastic, transparent	Plastic, transparent	Plastic, transparent
Sound module	Yes	Yes	Yes
Volume	95 dB/1 m	95 dB/1 m	95 dB/1 m
Audio frequencies	1 Hz, 5 Hz, continuous tone, pulse	1 Hz, 5 Hz, continuous tone, pulse	1 Hz, 5 Hz, continuous tone, pulse

IO-Link	Version 1.1	Version 1.1	Version 1.1
Transfer rate	COM 2 (38.4 kbaud)	COM 2 (38.4 kbaud)	COM 2 (38.4 kbaud)
Cycle time	5 ms with IO-Link 1.1 Master 20 ms with IO-Link 1.0 Master	5 ms with IO-Link 1.1 Master 20 ms with IO-Link 1.0 Master	5 ms with IO-Link 1.1 Master 20 ms with IO-Link 1.0 Master
IO-Link process data length	2-byte input	2-byte input	2-byte input
Communication indicators	Green LED	Green LED	Green LED

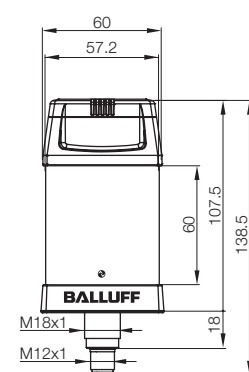
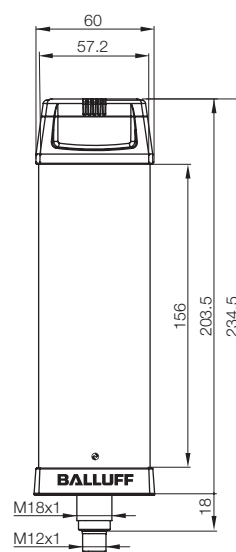
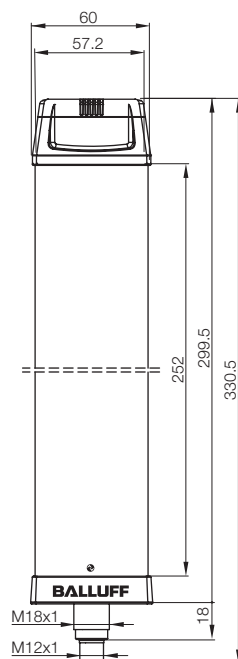

# IO-Link Devices

## SmartLight accessories



Designation	Pedestal for SmartLight <b>BAM026K</b>	Pedestal for SmartLight <b>BAM026L</b>	Wall holder for SmartLight <b>BAM0255</b>
Fastening	for M18 thread	for M18 thread	for M18 thread
Dimension	Ø 70 × 100 mm	Ø 70 × 400 mm	76 × 80 × 62 mm
Material	Anodized aluminum	Anodized aluminum	Anodized aluminum

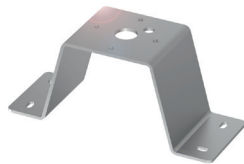

Designation	Pedestal for SmartLight <b>BAM02M5</b>
Fastening	Screws
Dimension	190 × 80 × 72 mm
Material	Anodized aluminum

# Connectors and Cables

## M12 female ↔ M12 male, 4-pin



Connector diagram and wiring



PUR, yellow	0.6 m	<b>BCC0H1C</b>	<b>BCC0H1K</b>
PUR, yellow	2 m	<b>BCC0H1E</b>	<b>BCC0H1L</b>
PUR, yellow	5 m	<b>BCC0H1F</b>	<b>BCC0H1M</b>
PUR, yellow	10 m	<b>BCC0H1H</b>	<b>BCC0H1N</b>
PUR, yellow	20 m	<b>BCC0H1J</b>	<b>BCC0H1P</b>
Supply voltage $U_S$		250 VAC/DC	250 VAC/DC
Cable		Molded	Molded
Number of conductors × conductor cross-section		4 × 0.34 mm <sup>2</sup>	4 × 0.34 mm <sup>2</sup>
Degree of protection as per IEC 60529		IP68	IP68
Ambient temperature $T_a$		-40...+90 °C	-40...+90 °C
Static/moving		-25...+90 °C (UL 80 °C)	-25...+90 °C (UL 80 °C)
Properties		Drag chain compatible	Drag chain compatible

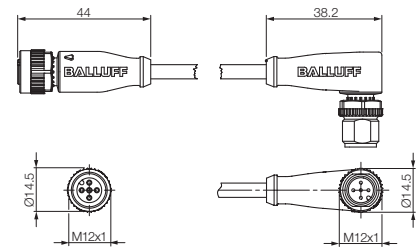
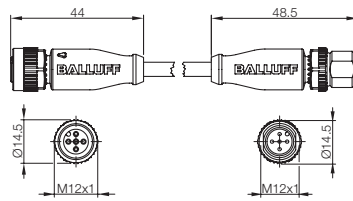



# Connectors and Cables

## M12 female ↔ M12 male, 5-pin

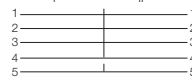
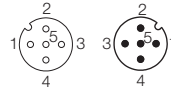
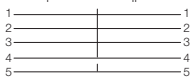
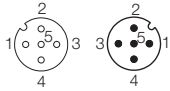

<b>BCC0H1R</b>	<b>BCC0H1Z</b>
<b>BCC0H1T</b>	<b>BCC0H20</b>
<b>BCC0H1U</b>	<b>BCC0H21</b>
<b>BCC0H1W</b>	<b>BCC0H22</b>
<b>BCC0H1Y</b>	<b>BCC0H23</b>
60 V AC/DC	60 V AC/DC
Molded	Molded
5 × 0.34 mm <sup>2</sup>	5 × 0.34 mm <sup>2</sup>
IP68	IP68
-40...+90 °C	-40...+90 °C
-25...+90 °C (UL 80 °C)	-25...+90 °C (UL 80 °C)
Drag chain compatible	Drag chain compatible

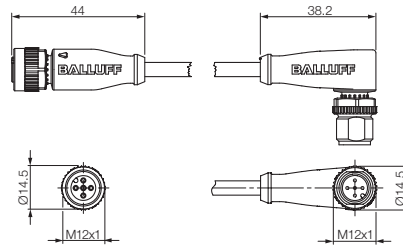
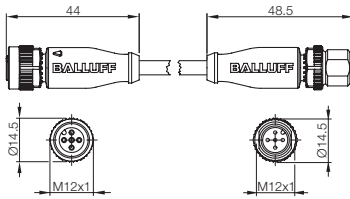

# Connectors and Cables

## M12 female, 8-pin

## M12 female ↔ M12 male, 8-pin



Connector diagram and wiring

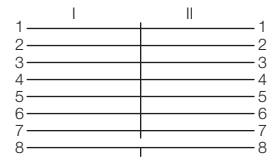
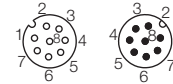
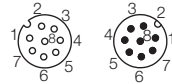

PUR, yellow	0.6 m		<b>BCC0H24</b>
PUR, yellow	2 m		<b>BCC0H25</b>
PUR, yellow	5 m	<b>BCC0H8N</b>	<b>BCC0H26</b>
PUR, yellow	10 m	<b>BCC0H8P</b>	<b>BCC0H27</b>
PUR, yellow	15 m	<b>BCC0H8R</b>	
PUR, yellow	20 m		<b>BCC0H28</b>
Supply voltage $U_B$		30 V AC/DC	30 V AC/DC
Cable		Molded	Molded
Number of conductors × conductor cross-section		8 × 0.34 mm <sup>2</sup>	8 × 0.34 mm <sup>2</sup>
Degree of protection as per IEC 60529		IP68	IP68
Ambient temperature $T_a$		-50...+80 °C	-50...+80 °C
Static/moving		-25...+80 °C	-25...+80 °C
Properties		Drag chain compatible	Drag chain compatible

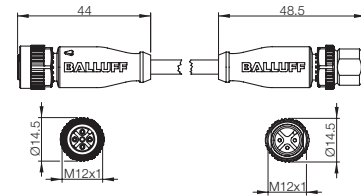
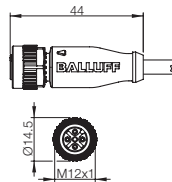

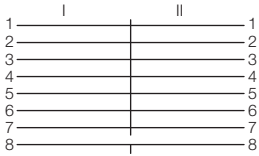
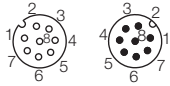

**BCC0H29**

**BCC0H2A**

**BCC0H2C**

**BCC0H2E**

**BCC0H2F**

30 V AC/DC

Molded

8 × 0.34 mm<sup>2</sup>

IP68

-50...+80 °C

-25...+80 °C

Drag chain compatible

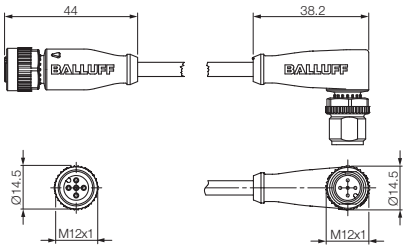

# Connectors and Cables

## M12 female ↔ M12 male, 3 and 4-pin



Connector diagram and wiring

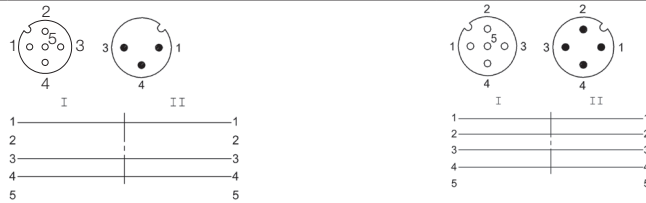

PUR, black	0.3 m	<b>BCC036Y</b>	<b>BCC039H</b>
PUR, black	0.6 m	<b>BCC036Z</b>	<b>BCC039J</b>
PUR, black	1 m	<b>BCC0370</b>	<b>BCC039K</b>
PUR, black	1.5 m	<b>BCC0371</b>	<b>BCC0FCE</b>
PUR, black	2 m	<b>BCC0372</b>	<b>BCC039L</b>
PUR, black	3 m	<b>BCC0373</b>	<b>BCC039M</b>
PUR, black	5 m	<b>BCC0374</b>	<b>BCC039N</b>
PUR, black	10 m	<b>BCC08HU</b>	<b>BCC039P</b>
Supply voltage $U_B$		250 V AC/DC	250 V AC/DC
Cable		Molded	Molded
Number of conductors × conductor cross-section		3 × 0.34 mm <sup>2</sup>	4 × 0.34 mm <sup>2</sup>
Degree of protection as per IEC 60529		IP68	IP68
Ambient temperature $T_a$		-50...+90 °C	-40...+90 °C
Static/moving		-25...+90 °C (UL 80 °C)	-25...+90 °C (UL 80 °C)
Properties		Drag chain compatible	Drag chain compatible

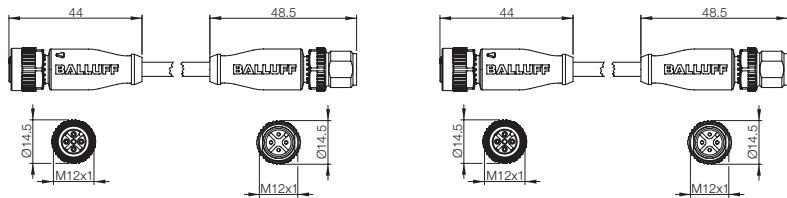





# Connectors and Cables

## 7/8" female, 5-pin



Connector diagram and wiring

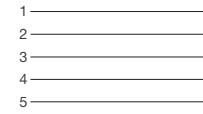
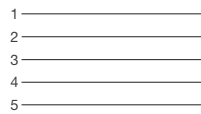
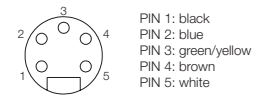
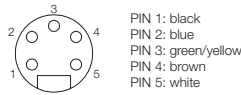

PUR, black/gray	0.6 m		
PUR, black/gray	2 m	<b>BCC06HC</b>	<b>BCC06HH</b>
PUR, black/gray	5 m	<b>BCC06HE</b>	<b>BCC06HJ</b>
PUR, black/gray	10 m	<b>BCC06HF</b>	<b>BCC06HK</b>
PUR, black	15 m		
PUR, gray	20 m		
Supply voltage AC $U_S$		300 V AC	300 V AC
Supply voltage DC $U_S$		300 V DC	300 V DC
Number of conductors × conductor cross-section		5 × 1.5 mm <sup>2</sup>	5 × 1.5 mm <sup>2</sup>
Degree of protection as per IEC 60529		IP68	IP68
Ambient temperature $T_a$		-25...+80 °C	-25...+80 °C
Properties		Drag chain compatible	Drag chain compatible

Other cable materials,  
colors and lengths on request.

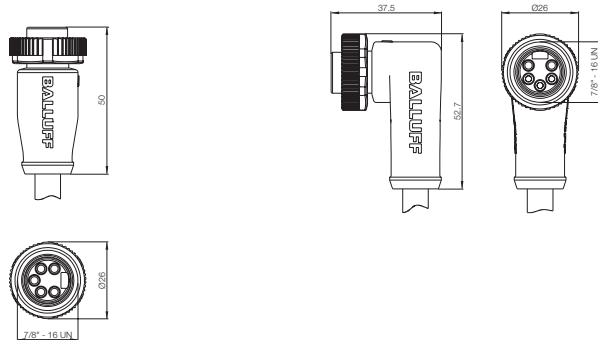

# Connectors and Cables

## 7/8" female ↔ 7/8" male, 5-pin Push/Pull

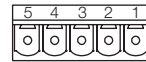
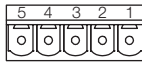
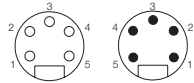
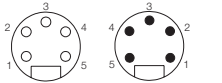

PIN 1: brown  
PIN 2: black  
PIN 3: gray  
PIN 4: blue  
PIN 5: green/yellow

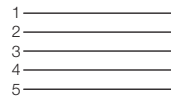
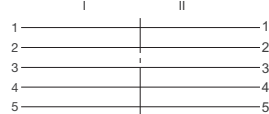
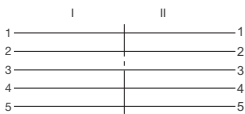

<b>BCC06FM</b>	<b>BCC06FU</b>	<b>BCC0F4M</b>
<b>BCC06FN</b>	<b>BCC06FW</b>	<b>BCC0F4N</b>
<b>BCC06FP</b>	<b>BCC06FY</b>	<b>BCC0F4P</b>
<b>BCC06FR</b>	<b>BCC06FZ</b>	<b>BCC0F4R</b>
<b>BCC06FT</b>	<b>BCC06H0</b>	<b>BCC0F4T</b>
300 V AC	300 V AC	24 V DC
300 V DC	300 V DC	24 V DC
5 × 1.5 mm <sup>2</sup>	5 × 1.5 mm <sup>2</sup>	5 × 2.5 mm <sup>2</sup>
IP68	IP68	IP67
-25...+80 °C	-25...+80 °C	-40...+70 °C
Drag chain compatible	Drag chain compatible	

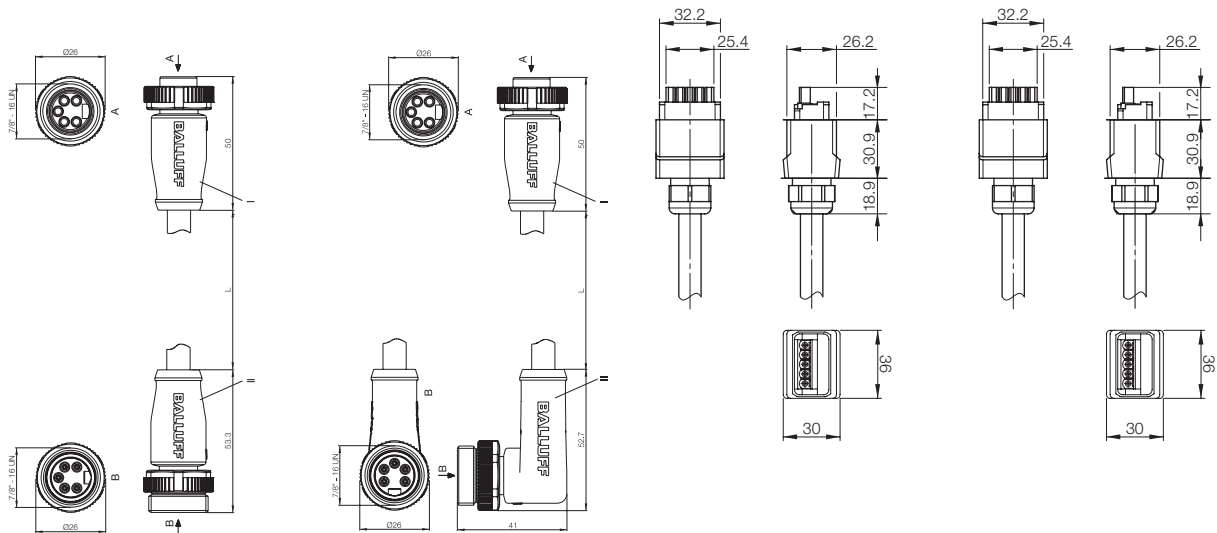

# Connectors and Cables

## Profinet, M12 male



Connector diagram and wiring

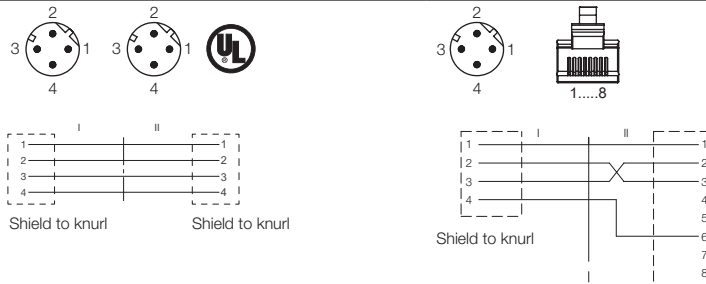

Type		M12 male straight/M12 male straight	M12 male straight/RJ45 male straight
PUR shielded, green	0.6 m	<b>BCC04K0</b>	<b>BCC04K6</b>
PUR shielded, green	2 m	<b>BCC04K1</b>	<b>BCC04K7</b>
PUR shielded, green	5 m	<b>BCC04K2</b>	<b>BCC04K8</b>
PUR shielded, green	10 m	<b>BCC04K3</b>	<b>BCC04K9</b>
PUR shielded, green	15 m	<b>BCC04ZH</b>	<b>BCC04ZJ</b>
PUR shielded, green	20 m	<b>BCC04K4</b>	<b>BCC04KA</b>
PUR shielded, green	30 m	<b>BCC04K5</b>	<b>BCC04KC</b>
Supply voltage $U_B$		60 V AC/DC	60 V AC/DC
Number of conductors x conductor cross-section		4 x 22 AWG	4 x 22 AWG
Degree of protection as per IEC 60529		IP68	IP68/IP20
Ambient temperature $T_a$		-20...+60 °C	-20...+60 °C
Properties		Drag chain compatible	Drag chain compatible

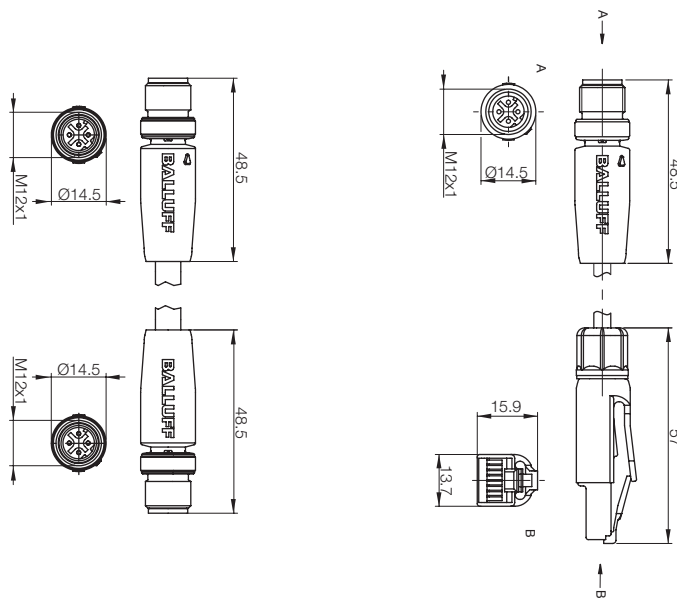

# Connectors and Cables

## Profinet, Push-Pull

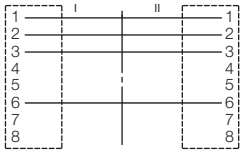
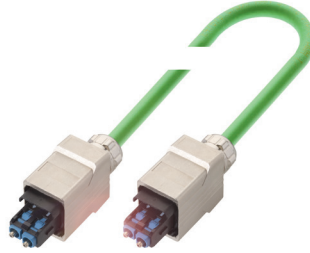
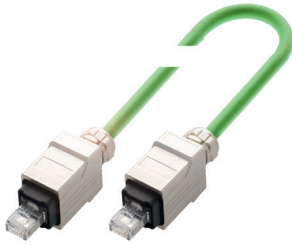

BCC0F4U  
BCC0F4W  
BCC0F4Y  
BCC0F4Z

BCC0F51  
BCC0F52  
BCC0F53  
BCC0F54

BCC0F50

BCC0F55

50 V DC  
4 × 0.34 mm<sup>2</sup>  
IP67  
-40...+70 °C  
Drag chain compatible

24 V DC  
2 × Ø 1 mm  
IP67  
-20...+70 °C  
Drag chain compatible

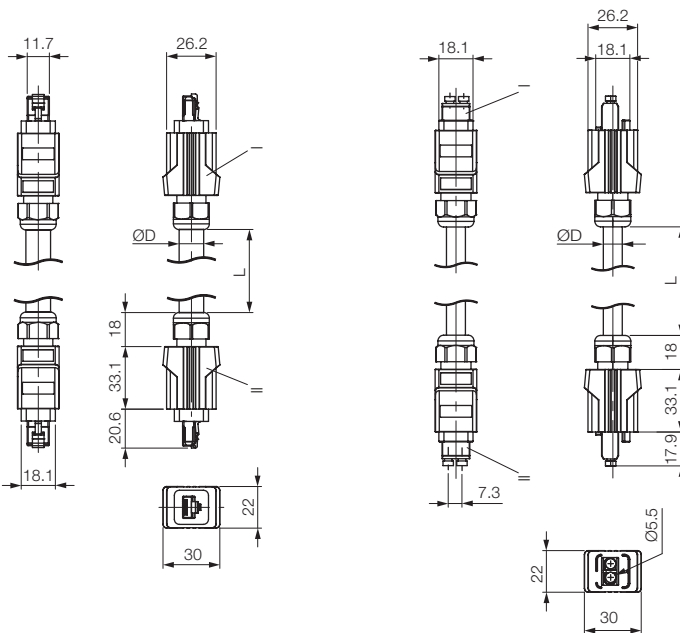

# Accessories

## Tee, holder, mounting bracket



Designation	Tee	Tee	Tee
	<b>BCC09MU</b>	<b>BCC0F58</b>	<b>BCC07WR</b>
Head 1	M12 male, 5-pin	M12 male, 5-pin	M12 female, 5-pin
Head 2	M12 female, 5-pin	M12 female, 5-pin	M12 female, 5-pin
Head 3	M12 female, 5-pin	M12 female, 5-pin	M12 male, 5-pin



Designation	Rotatable mounting bracket	Rotatable mounting bracket	Mounting brackets
	<b>BAM02N2</b>	<b>BAM02NC</b>	<b>BAM02MZ</b>
Dimensions	70 × 46 mm	35 × 39.6 × 29.7 mm	34.5 × 30.7 × 37.8 mm
Use	For BLG safety light curtain	For BLG safety light curtain	For BLG safety light curtain
Set consisting of	4-part kit	4-part kit	4-part kit
Material	Galvanized steel	Galvanized steel	Galvanized steel



# Accessories

## Holder, clamp



Designation	Holder, vibration-damping	Holder, vibration-damping
	<b>BAM02N6</b>	<b>BAM02N7</b>
Use	For BLG safety light curtain, mounting bracket BAM02MZ	For BLG safety light curtain, mounting bracket BAM02MZ
Dimension	Ø 25 mm	Ø 25 mm
Set consisting of	4-part kit	6-part kit
Material	Rubber	Rubber

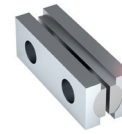
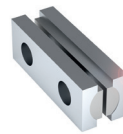
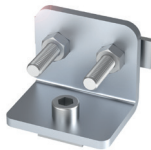

Clamp for light grid	Clamp for light grid	Holder, adjustable	Holder, adjustable
<b>BAM02N4</b>	<b>BAM02N5</b>	<b>BAM02N0</b>	<b>BAM02N1</b>
34.5 × 26.5 × 30 mm	34.5 × 26.5 × 30 mm	34.5 × 12 mm	34.5 × 12 mm
For BLG safety light curtain up to 1050 mm	For BLG safety light curtain starting 1200 mm	For BLG safety light curtain up to 1050 mm	For BLG safety light curtain starting 1200 mm
4-part kit	6-part kit	4-part kit	6-part kit
Galvanized steel	Galvanized steel	Anodized aluminum	Anodized aluminum

# Accessories

## Deflection mirror, floor holder, laser pointer, test rod



Designation	Deflector mirror
Use	for floor holder
Material	Steel/glass
580 × 89 × 36 mm	<b>BAM02NL</b>
880 × 89 × 36 mm	<b>BAM02NM</b>
1180 × 89 × 36 mm	<b>BAM02NN</b>
1630 × 89 × 36 mm	<b>BAM02NP</b>
1880 × 89 × 36 mm	<b>BAM02NR</b>



Designation	Floor stand
Use	For BLG safety light curtain or deflection mirror
Material	Painted aluminum
617.9 × 195 × 195 mm	<b>BAM02NE</b>
1017.9 × 195 × 195 mm	<b>BAM02NF</b>
1217.9 × 195 × 195 mm	<b>BAM02NH</b>
1667.9 × 195 × 195 mm	<b>BAM02NJ</b>
1917.9 × 195 × 195 mm	<b>BAM02NK</b>

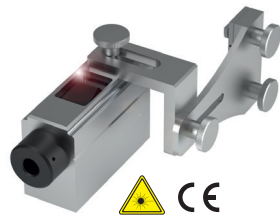

Designation	Laser-Pointer
Use	For BLG safety light curtain
	<b>BAE00WJ</b>
Dimension	81 × 44 × 26.6 mm
Material	Anodized aluminum



Designation	Test rod
Use	For BLG safety light curtain
	<b>BAM02P9</b>
Dimension	Ø 14 × 300 mm
Material	Anodized aluminum

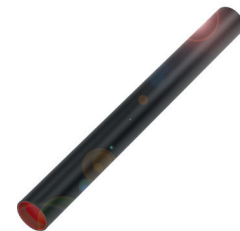

Designation	Test rod
Use	For BLG safety light curtain
	<b>BAM02PA</b>
Dimension	Ø 30 × 300 mm
Material	Anodized aluminum

## Accessories

### Tamper protection, mounting kit for deflector mirror



Type	Tamper protection	Mounting kit for deflector mirror
	<b>BAM01Z4</b>	<b>BAM02N3</b>
Use	for M12 connector	for deflector mirror and floor holder
Material	Polyamide	Galvanized steel

**Headquarters**  
Balluff GmbH  
Schurwaldstrasse 9  
73765 Neuhausen a. d. F.  
Germany  
Phone +49 7158 173-0  
Fax +49 7158 5010  
balluff@balluff.de

[www.balluff.com](http://www.balluff.com)

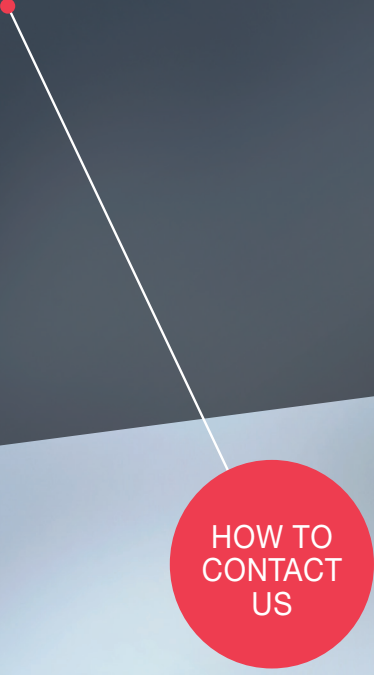

HOW TO  
CONTACT  
US